

DORN
BRACHT

YOUR SPACE

Kitchen



Leading Designs for Architecture

OF LIFE

EXPERIENCE OUR KITCHEN SERIES MEM
ON PAGE 70 →



EN “Your Space of Life” – that’s exactly what the kitchen is. An exceedingly personal space where everyone has their very own expectations. Our highest aspiration is to fulfil this to the best of our abilities. Making a decision for Dornbracht is always a decision for exceptional quality, skilled craftsmanship, and sustainable production “Made in Iserlohn”. And for maximum individuality. We guarantee this, not only with our characteristic design series, but also with the tremendous selection of finishes, functionalities and accessories. When they are perfectly matched to each other, it’s these details that make a kitchen “your” kitchen.

On the following pages, we celebrate the kitchen as the room and hub for home life, entirely in line with our promise of “Leading Designs for Architecture” with interiors and architectures that set progressive impulses; intended to inspire and delight you with well-planned, aesthetically durable products that will sustainably enrich your life in the kitchen.”

IT “Your Space of Life” – questo è l’ambiente cucina. Un luogo estremamente personale dove ognuno ha le proprie esigenze. Dornbracht aspira a migliorare continuamente i propri livelli qualitativi, di artigianalità e produzione sostenibile “Made in Iserlohn”. A favore della massima individualità: garantita dalle nostre serie dal design caratteristico complete di accessori disponibili in un’ampia gamma di finiture e funzionalità. Sono i dettagli perfettamente coordinati che rendono una cucina la ‘vostra’ cucina.

Nelle pagine seguenti, celebriamo la cucina come spazio abitativo e punto focale, in linea con la nostra promessa “Leading Designs for Architecture”: con interni e architetture ispirazionali. Ogni prodotto è stato accuratamente scelto per essere esteticamente durevole e funzionale incrementando in modo reale e sostenibile la vostra vita in cucina.”

ES “Your space of Life”, esto es exactamente la cocina. Un lugar totalmente personal para el que cada cual tiene sus propios deseos. Colmarlos de la mejor manera posible es nuestra mayor aspiración. Por ello, elegir Dornbracht asegura siempre una calidad excepcional, trabajo artesanal y fabricación sostenible “made in Iserlohn”. Y también la máxima individualización: esto no solo lo garantizamos con nuestras series de diseño características, sino también con la gran variedad de acabados, funciones y complementos. Y es que, en una armonía perfecta, son precisamente esos detalles los que convierten una cocina en “su” cocina.

En las próximas páginas celebramos la cocina como espacio de vida protagonista, siguiendo nuestro lema “Leading Designs for Architecture”: con interiores y arquitecturas que constituyen impulsos vanguardistas, que pretenden inspirarle y entusiasmarle. Y con productos ingeniosos y de larga vida estética que enriquecen de verdad su vida en la cocina.

Stefan Gesing CEO Dornbracht

KITCHEN

009	Design principles Design Principles Principios de diseño
015	Functional highlights Approfondimenti funzionali Funcionalidad destacada
029	Finishes Finiture Acabados
035	Kitchen sinks and accessories Lavelli e accessori da cucina Fregaderos de cocina y complementos
041	Your Space of Life

CONTENTS

Design Collections	047
VAIA	050
MEM	068
META SQUARE	084
TARA	100
TARA ULTRA	116
LOT	134
SYNC	150
ELIO	166
ENO	182
x-tra Service	199
Sustainability Sostenibilità Sostenibilidad	203

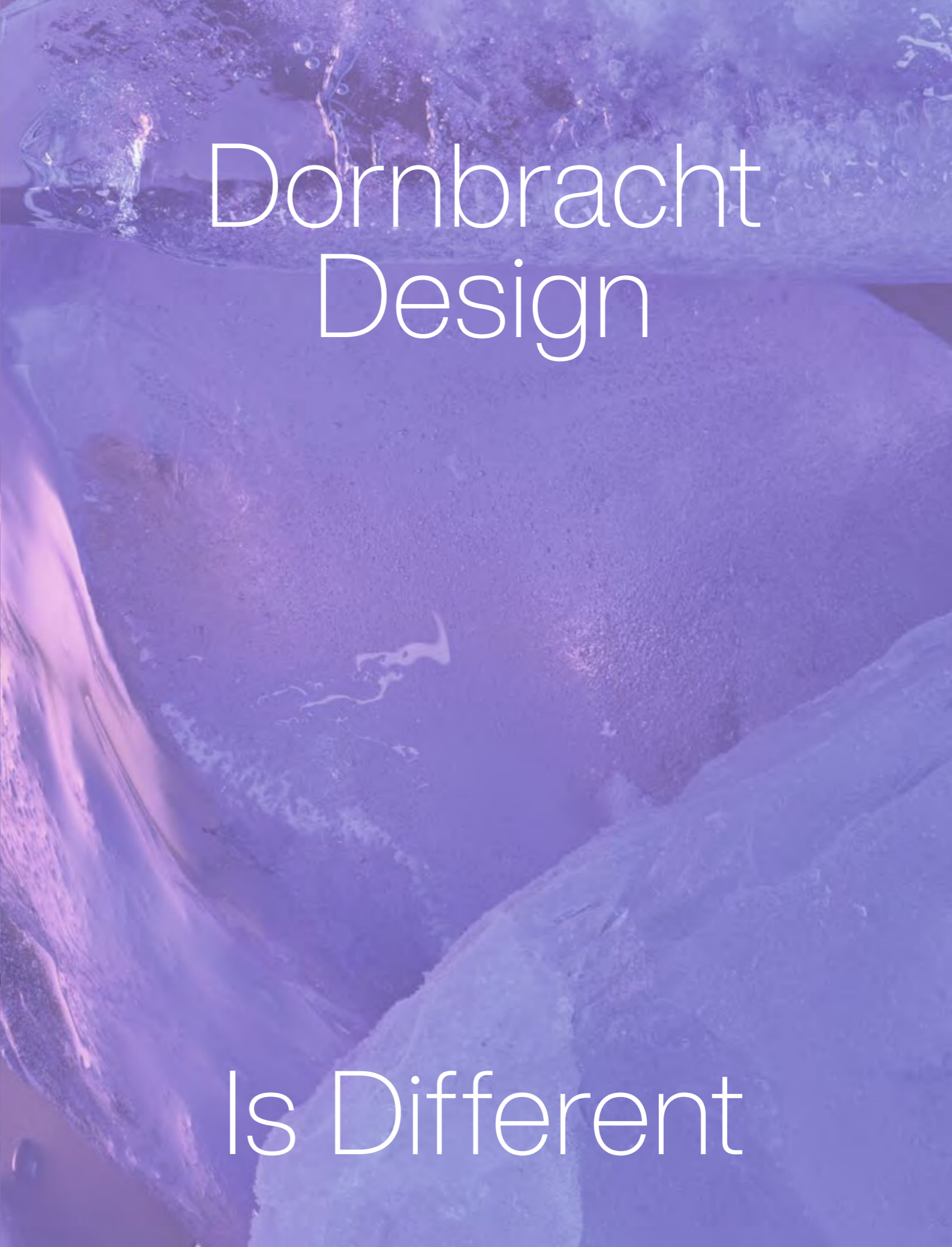

Dornbracht
Design

Is Different

^{EN} Dornbracht constantly strives for uniqueness and excellence – and to ensure these high standards are met, we base our development on five design principles.

^{IT} Dornbracht punta sempre all'unicità e all'eccellenza: per garantire questo standard elevato, lo sviluppo dei nostri prodotti si basa su cinque principi di progettazione.

^{ES} Dornbracht persigue siempre el carácter único y la excelencia: para garantizarlos, nuestros desarrollos se basan en cinco principios de diseño.

The Design Principles – Striving for Excellence



1 PROPORTION



2 PRECISION

4 PERFORMANCE



3 PROGRESSIVENESS

5 PERSONALITY

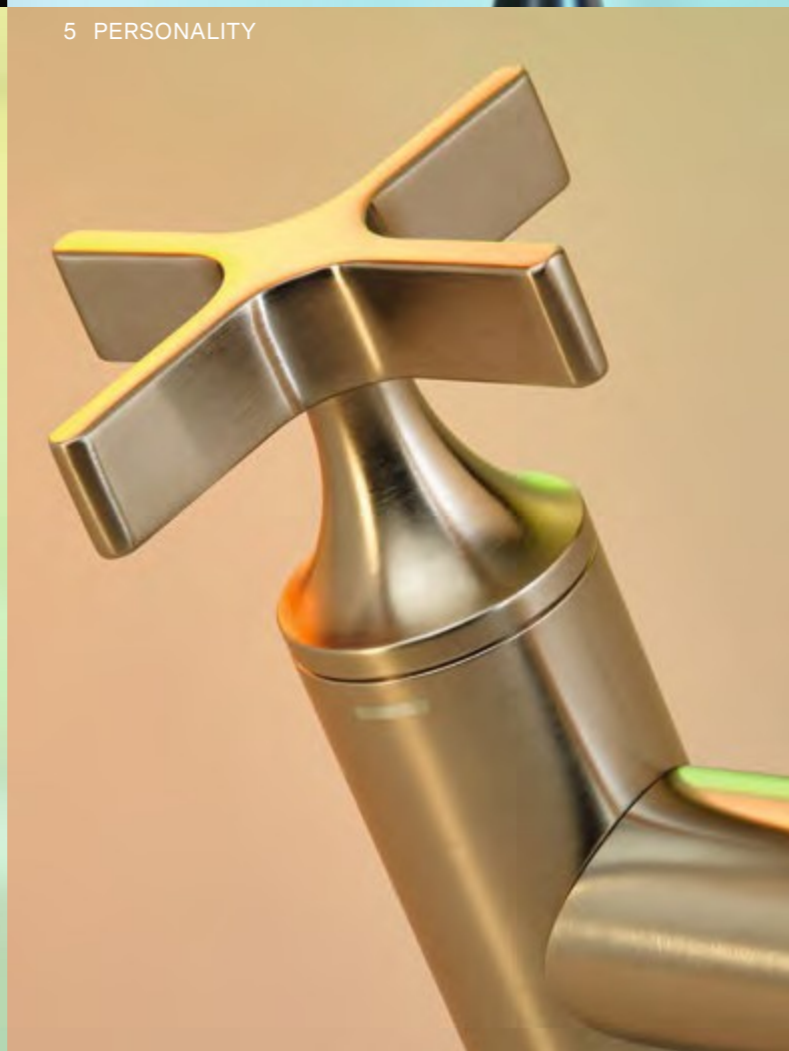

1 PROPORTION

^{EN} Dornbracht fittings are perfectly proportioned. Their design is in keeping with a timeless ideal – balanced, harmonious, and precise. It is this perfection that explains their iconic and enduring aesthetic appeal.

^{IT} I rubinetti Dornbracht hanno proporzioni perfette. Il loro design segue un ideale senza tempo: equilibrato, armonioso e preciso. Questa perfezione stabilisce la loro estetica iconica e duratura.

^{ES} Las griferías Dornbracht presentan proporciones perfectas. Su diseño sigue un ideal atemporal: equilibrado, armonioso y exacto. Esta perfección explica su estética icónica y duradera.

2 PRECISION

^{EN} Dornbracht fittings epitomise uncompromising precision. Their form is characterised by clean lines and precise radii, their workmanship of superb finishes and the highest quality of manufacturing. Even the smallest details are accomplished with unrivalled care.

^{IT} I rubinetti Dornbracht sono sinonimo di precisione senza compromessi. Linee chiare e raggi precisi caratterizzano la loro forma, le finiture di prima classe e la massima qualità di fabbricazione e lavorazione. La cura con cui vengono realizzati anche i più piccoli dettagli è impareggiabile.

^{ES} Las griferías Dornbracht son sinónimo de precisión incondicional. Líneas claras y radios exactos caracterizan su forma, acabados de primera y la máxima calidad de manufactura. El mimo con el que se plasman incluso los más ínfimos detalles no tiene par.

3 PROGRESSIVENESS

^{EN} Dornbracht fittings are progressive. They show an enlightened attitude that is receptive to anything new. They provide inspiration for architectures and interior designs with a visionary aspiration. They set present-day and future benchmarks, in constant dialogue with the spirit of the age.

^{IT} I rubinetti Dornbracht sono concepiti con una mentalità innovativa, sempre aperta alle novità. Offrono ispirazione per l'architettura e l'interior design con un'ottica innovativa, in costante dialogo con lo spirito dei tempi, stabiliscono standard per il presente e per il futuro.

^{ES} Los productos Dornbracht son progresivos. Siguen un patrón vanguardista y abierto a lo nuevo, e inspiran a arquitecturas y diseños de interiores con su pretensión visionaria. En un diálogo constante con los referentes actuales, crean nuevos espacios para el presente y el futuro.

4 PERFORMANCE

^{EN} Dornbracht fittings epitomise excellent performance. The highest standards of functionality and application direct the focus onto the diverse forms of water presentation. These provide enhancement by creating unique water experiences and added value.

^{IT} I rubinetti Dornbracht sono sinonimo di prestazioni eccellenti. Le massime esigenze in termini di funzionalità e applicazione indirizzano l'attenzione su diverse forme di erogazione dell'acqua che arricchiscono la vostra esperienza.

^{ES} Las griferías Dornbracht son sinónimo de excelencia. Las más altas exigencias de funcionalidad y uso se centran en las variadas formas de hacer fluir al agua. Esto da lugar a experiencias acuáticas únicas y a valores añadidos que enriquecen nuestras vidas.

5 PERSONALITY

^{EN} Dornbracht fittings are originals with personality. They always embody an independent character – making an individual and incisive statement as they do. Their unmistakable identity is the result of the interplay between distinctive form and expressive finishes.

^{IT} I rubinetti Dornbracht sono originali e unici nell'esprimere la loro personalità. La loro identità inconfondibile è il risultato dell'interazione di forme concise ed individuali con finiture luminose ed espressive.

^{ES} Las griferías Dornbracht son piezas genuinas con personalidad. Reflejan siempre un carácter propio, creando así individualidad y genuinidad. Su identidad inconfundible se deriva de la fusión de formas llamativas y acabados de gran expresividad.



Find out more:
dornbracht.com/design-principles



Functional Highlights



Elegant
and Efficient

PULL-DOWN WITH LAMINAR FLOW
DISCOVER MORE ON PAGE 152 →



^{EN} PULL-DOWN and PULL-OUT fittings make the daily hand movements in the kitchen easier. The pull-out element can be pulled downwards or towards you. There is a choice of various flow modes, depending on the product model, namely spray, laminar, or air-enriched flow.

^{IT} I rubinetti PULL-DOWN e PULL-OUT rendono più confortevoli le operazioni quotidiane in cucina. L'elemento doccetta si può estrarre verso il basso o in avanti. Sono possibili diversi tipi di getto, a seconda del modello di prodotto: getto laminare o arricchito d'aria.

^{ES} Las griferías PULL-DOWN y PULL-OUT logran que los movimientos cotidianos en la cocina resulten más cómodos. El elemento final puede ser extraído hacia abajo o hacia delante. Dependiendo del modelo de producto, existen diferentes tipos de chorro disponibles: chorro concentrado, laminar o enriquecido con aire.

PULL-OUT Function & PULL-DOWN Function



EN Very practical: the flexible pull-out element offers an extended radius of action in the kitchen.

IT Particolarmente pratico: l'elemento estraibile completo di flessibile offre un raggio d'azione più esteso in cucina.

ES Especialmente práctico: el elemento extraíble flexible permite disfrutar de un mayor radio de acción en la cocina.

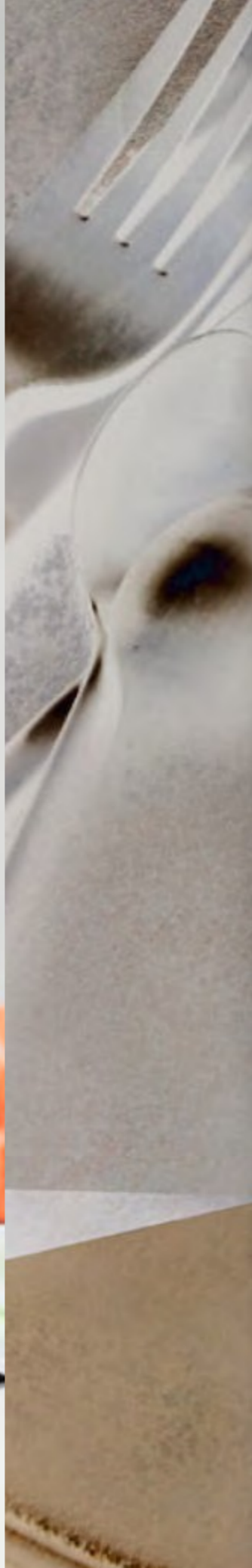

Professional Use

^{EN} Inspired by professional kitchens: our Profi fittings and side fittings combine award-winning design with the highest functionality. They provide thorough and point-specific support with all the daily activities at the water point.

^{IT} Ispirato alle cucine professionali: i nostri miscelatori e le doccette laterali combinano un design eccellente con la massima funzionalità. Forniscono un supporto completo e preciso per le operazioni quotidiane all'interno del lavello.

^{ES} Inspirado en cocinas profesionales: nuestras griferías Profi y los grifos Profi laterales conjugan un magnífico diseño con la máxima funcionalidad. Y nos respaldan de forma precisa y exacta en los movimientos cotidianos de la zona del fregadero.



TARA ULTRA PROFI WITH
SPRAY FLOW AND AIR-ENRICHED FLOW
DISCOVER MORE ON PAGE 126 →

POT FILLER & PIVOT



EN Perfect Twist: PIVOT and POT FILLER have a swivel spout that turns flexibly in all directions, so pots and containers can be filled directly by the hob.

IT Perfect Twist: PIVOT e POT FILLER hanno una bocca girevole che si può ruotare in modo flessibile in tutte le direzioni. In questo modo, pentole e contenitori si possono riempire direttamente nella zona cottura.

ES Giro perfecto: PIVOT y POT FILLER disponen de un caño de salida giratorio que puede girarse en todas las direcciones. De este modo, es posible llenar ollas y recipientes directamente en la placa de cocina.



A PLACE FOR CULINARY EXPERIENCES AND A MEETING PLACE - ACTS OF EATING AND COOKING TOGETHER - TRACES OF ENCOUNTER. THE ARCHITECTURE OF COOKING BASED ON ACTION AND MEMORIES. YOUR SPACE OF LIFE. A PLACE FOR CULINARY EXPERIENCES AND A MEETING PLACE





Finishes

Perfection in
Every Dimension



Brushed Durabronz (23kt Gold)



^{EN} Dornbracht considers its surface finishes as an independent element in design. By combining technological expertise with outstanding design, Dornbracht is always able to keep setting exceptional standards.

^{IT} Dornbracht considera le finiture come una dimensione progettuale indipendente. Grazie a questa interazione di competenza tecnologica e un elevato livello di esperienza, Dornbracht continua a fissare standard elevati.

^{ES} Dornbracht considera los acabados como una dimensión de configuración independiente. Esta combinación de experiencia tecnológica y alta competencia de diseño permite a Dornbracht crear regularmente referentes extraordinarios.



Dark Chrome

^{EN} Dornbracht offers a wide range of curated finishes to suit your individual requirements and style.

^{IT} Dornbracht offre un'ampia gamma di finiture adatte ad ogni stile ed esigenza.

^{ES} Para sus necesidades y su estilo personales, Dornbracht ofrece una amplia gama de acabados seleccionados.



Durabronze (23kt Gold)
Brushed Durabronze (23kt Gold)



Sinks & Accessories

Make it Match



^{EN} Let our design series inspire you, and find the perfect match for your kitchen – including modern kitchen sinks. Their material quality meets the highest standards for robustness and aesthetics.

^{IT} Lasciatevi ispirare dalla nostra serie di design e trovate l'abbinamento perfetto per la vostra cucina, compresi i moderni lavelli. La qualità dei materiali soddisfa i più elevati standard di robustezza ed estetica.

^{ES} Déjese inspirar por nuestras series de diseño y encuentre los modelos perfectos para su cocina: incluyendo modernos fregaderos. Su calidad de material colma todas las exigencias de robustez y estética.



EN Everything from a single source, and perfect for combining: Dornbracht has practical detergent dispensers and a range of other accessories, such as the pop-up waste with knob or the rinsing spray on the side, for your kitchen.

IT Tutto da un'unica fonte e perfettamente combinabile: Dornbracht dispone di pratici dispenser di detersivo e altri accessori per la vostra cucina, come il comando piletta esterno o la doccetta da piano.

ES Todo a mano, y combinable a la perfección: para su cocina, Dornbracht dispone de prácticos dispensadores de detergente y más complementos, como por ejemplo el accionamiento exéntrico con selector giratorio o el juego de ducha lateral.





Your Space

of Life

^{EN} The kitchen: the centre of life and a room that is full of emotions – where functionality meets aesthetics, and aspiration meets taste.

^{IT} La cucina: il centro della vita, uno spazio ricco di emozioni dove la funzionalità si sposa con l'estetica e l'aspirazione con il gusto.

^{ES} La cocina: el centro de la vida y un espacio lleno de emociones, en el que la funcionalidad, la estética y la exigencia se conjugan con el buen gusto.



More Than Just a Place to Cook

Divine Chaos





Design
THE
PERFECT
MATCH

FOR YOUR
KITCHEN
Collections



VAIA



TARA ULTRA

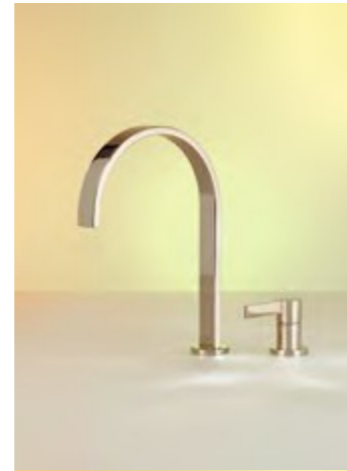

MEM

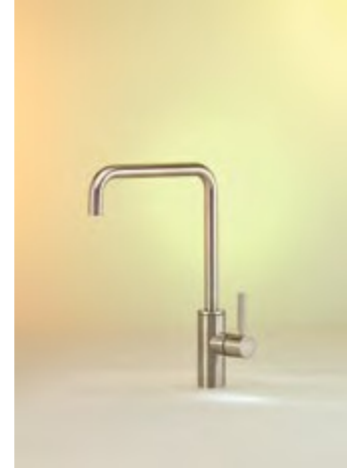

META SQUARE

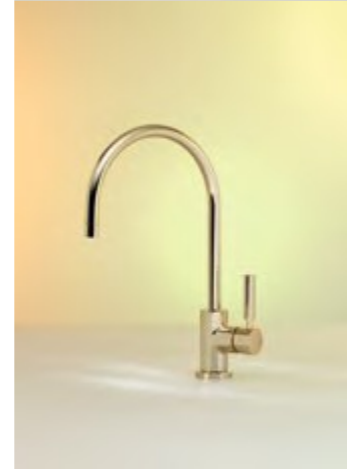

TARA



LOT



SYNC

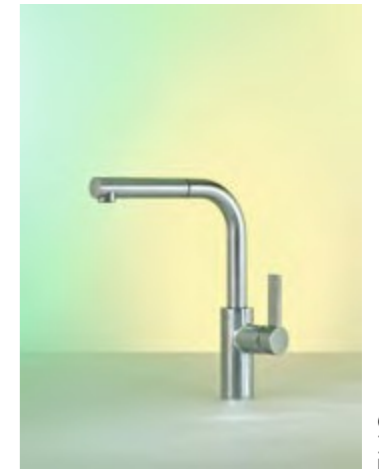

ELIO

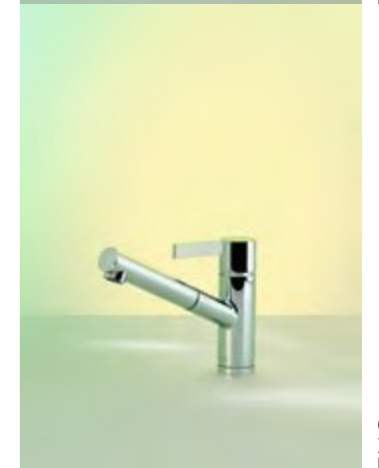

ENO

- 050 VAIA
- 068 MEM
- 084 META SQUARE
- 100 TARA
- 116 TARA ULTRA
- 134 LOT
- 150 SYNC
- 166 ELIO
- 182 ENO

VAIA

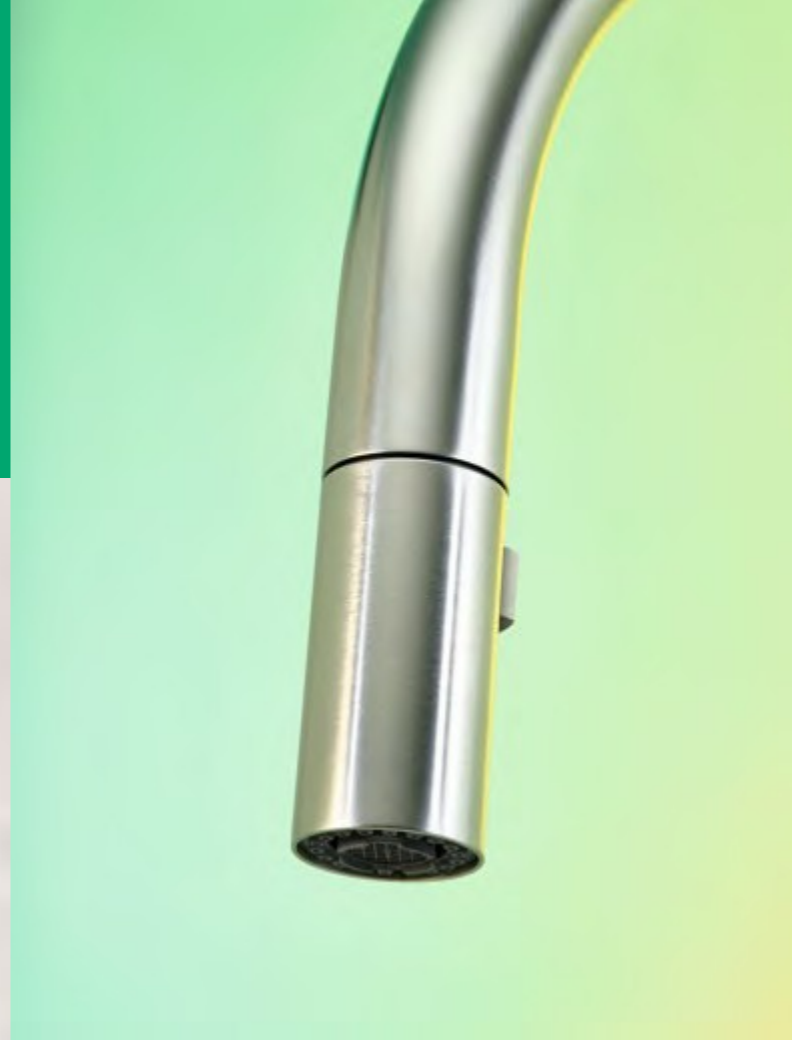

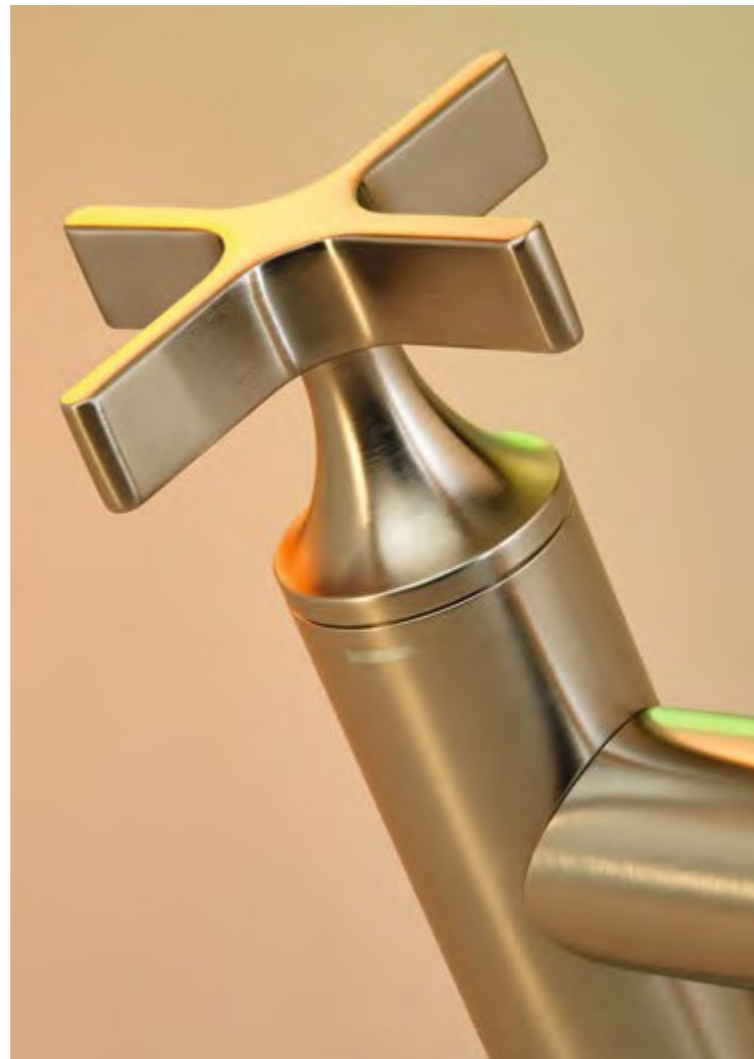

^{EN} VAIA combines tradition and modernity. Its graceful design language with the filigree lines and open silhouette creates a balance between the familiar and the new.

^{FR} VAIA unisce tradizione e modernità. Il suo linguaggio di design aggraziato dalla silhouette aperta crea un equilibrio tra familiarità e novità.

^{ES} VAIA combina tradición y modernidad. Su encanto formal de líneas interesantes y una silueta abierta crea un equilibrio entre lo conocido y lo nuevo.



The Graceful



VAIA BRUSHED PLATINUM

graceful
delicate
balanced

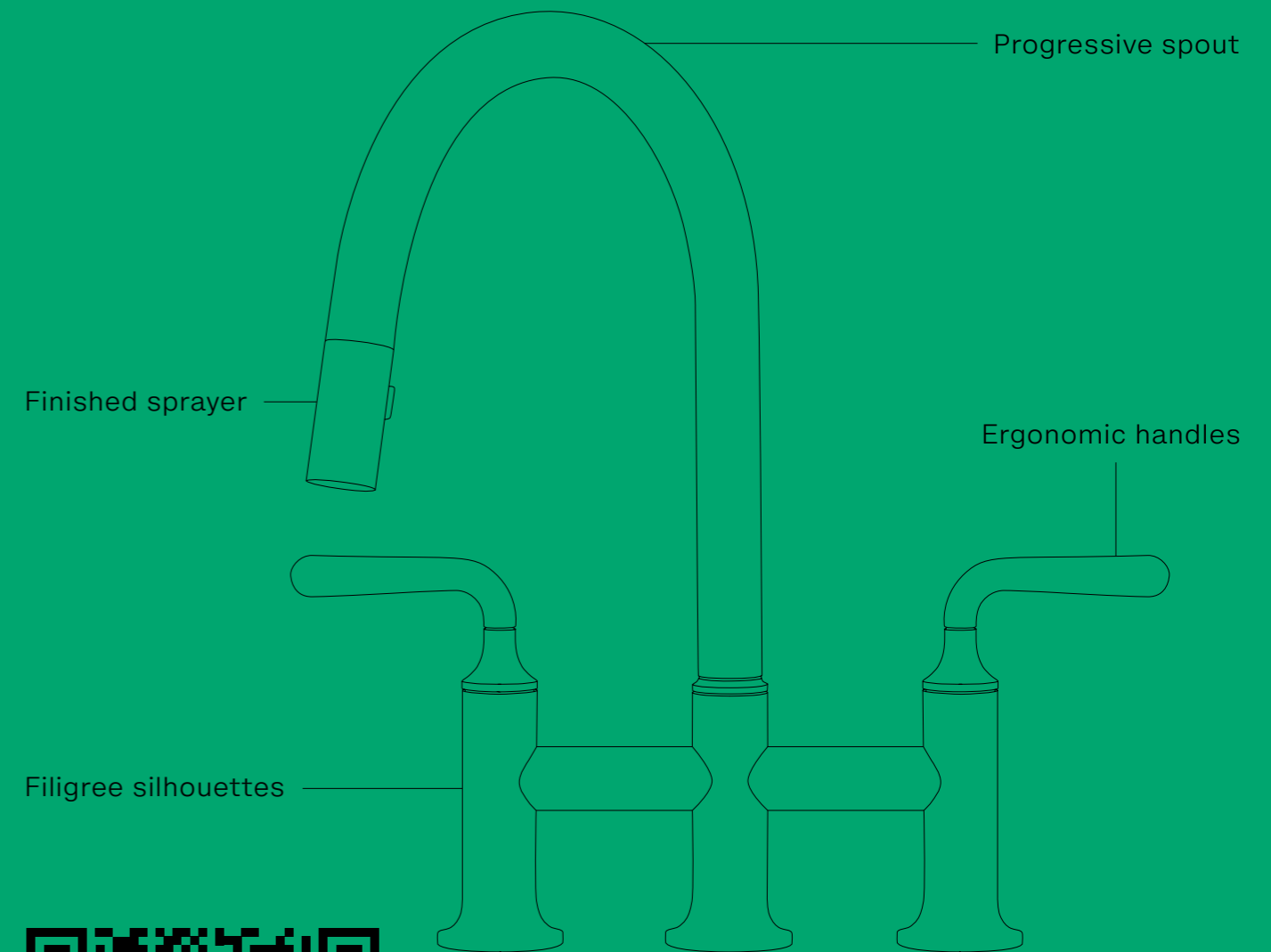

Find out more about VAIA at dornbracht.com/vaia-kitchen



Metropolitan Eclecticism

EN A modern open plan kitchen with a metropolitan spirit where matching style elements are combined with taste and variety. The kitchen island and bar stools are perfect for relaxing.

IT Una moderna cucina abitabile dallo spirito metropolitano, in cui gli elementi di stile si combinano in modo variegato. L'isola della cucina e gli sgabelli da bar invitano a fermarsi per una pausa.

ES Una cocina-comedor moderna de aire metropolitano en la que se combinan elementos de estilo a juego de forma variada. La isla de la cocina y los taburetes de bar invitan a pasar tiempo en este espacio.



^{EN} VAIA in the warm Brushed Durabronze (23kt gold) finish is particularly effective when used together with natural colours.

^{IT} Nella calda finitura Ottone spazzolato (Oro 23k), VAIA viene particolarmente evidenziata in combinazione con i colori naturali dell'ambiente.

^{ES} En el cálido acabado Latón cepillado (Oro 23k) VAIA brilla especialmente en combinación con colores naturales.



According to
Your Taste

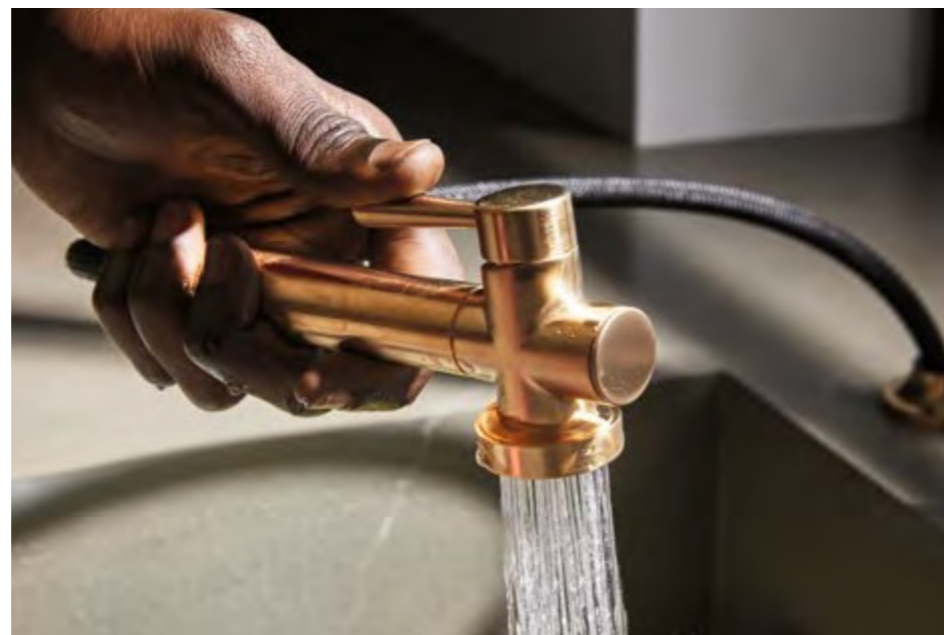

EN The POT FILLER and rinsing spray on the side will support you with your daily movements in the kitchen. Award-winning design is combined with a high level of functionality that suits your needs and style.

IT POT FILLER e doccetta lavello laterale da piano offrono supporto nelle attività quotidiane in cucina. Il design eccellente si combina con un alto livello di funzionalità che si adatta alle vostre esigenze e al vostro stile.

ES POT FILLER y el grifo de mano le respaldan a la hora de realizar movimientos cotidianos en la cocina. El magnífico diseño se combina aquí con una alta funcionalidad, que se adapta a sus demandas y a su estilo.





light linen
oasis brown marble
oak wood & asphalt
screed
kitchen wallpaper



Materials



VAIA

Selected Products

EN Whether a single-lever mixer, or a bridge mixer with levers or cross-handles, discover VAIA's many different designs, and explore the suitable options for your kitchen.

IT Scoprite VAIA nella sua vasta gamma di opzioni adatte per la vostra cucina dal miscelatore monocomando, alla batteria a ponte con leve oppure con manopole a croce.

ES Tanto en versión monomando, como en batería puente americana con manetas o crucetas: descubra VAIA en sus variadas ejecuciones y sus opciones adecuadas para su cocina.

Product Information
 Informazioni sui prodotti
 Información de producto

^{EN} Excerpt from the product range.
 More detailed information can be obtained from your dealer. Due to the printing technique used here, the colours shown may vary from the true colour of the actual finish.

^{IT} Estratto dalla gamma completa prodotti.
 Il Vostro rivenditore specializzato sarà lieto di fornirvi maggiori informazioni. Per motivi tecnici di stampa non possiamo garantire la fedeltà dei colori qui riprodotti.

^{ES} Extracto del programa de productos.
 Si desea más información consulte con su comercio habitual. Los acabados reproducidos en el presente catálogo no son vinculantes por razones de impresión.

Finishes for fittings
 Finiture rubinetteria
 Acabados grifería



00
 Chrome
 Cromato
 Cromo

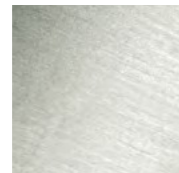

93
 Brushed Chrome
 Cromo spazzolato
 Cromo cepillado



08
 Platinum
 Platinato
 Platino

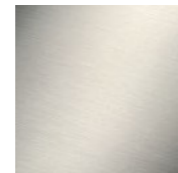

06
 Brushed Platinum
 Platinato spazzolato
 Platino cepillado



47
 Champagne (22kt Gold)
 Champagne (Oro 22k)
 Champagne (Oro 22k)

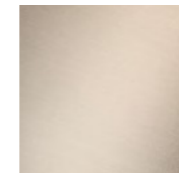

46
 Brushed Champagne
 (22kt Gold)
 Champagne spazzolato
 (Oro 22k)
 Champagne cepillado
 (Oro 22k)

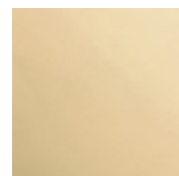

09
 Durabress (23kt Gold)
 Ottone (Oro 23k)
 Latón (Oro 23k)

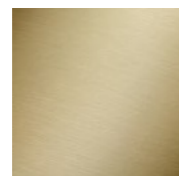

28
 Brushed Durabress
 (23kt Gold)
 Ottone spazzolato
 (Oro 23k)
 Latón cepillado (Oro 23k)



19
 Dark Chrome
 Dark Chrome
 Dark Chrome

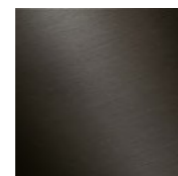

99
 Brushed Dark Platinum
 Dark Platinum spazzolato
 Dark Platinum cepillado



33
 Matte Black
 Nero opaco
 Negro mate

Fittings
 Rubinetti
 Griferías



33 870 809
 Single-lever mixer Pull-down with spray function
 Miscelatore monocomando ad estrazione Pull-down con funzione doccia
 Monomando Pull-down con función de chorro
 [max. 7 l/min.]



33 826 809 + 27 718 809
 Single-lever mixer with side spray set
 Miscelatore monocomando con gruppo doccia lavello
 Monomando con rociador de cocina
 [max. 7 l/min.]



33 805 809
 BAR TAP Single-lever mixer
 BAR TAP Miscelatore monocomando
 BAR TAP Monomando
 [max. 7 l/min.]



19 870 809
 Three-hole bridge mixer Pull-down with spray function
 Batteria arcata a tre fori Pull-down con funzione doccia
 Batería puente americana Pull-down con función de chorro
 [max. 7 l/min.]



33 800 809
 Single-lever mixer
 Miscelatore monocomando
 Monomando
 [max. 7 l/min.]



19 875 809
 Three-hole bridge mixer Pull-down with spray function
 Batteria arcata a tre fori Pull-down con funzione doccia
 Batería puente americana Pull-down con función de chorro
 [max. 7 l/min.]



33 810 809 + 27 718 809
 Single-lever mixer with side spray set
 Miscelatore monocomando con gruppo doccia lavello
 Monomando con rociador de cocina
 [max. 7 l/min.]



19 815 809 + 27 718 809
 Two-hole lavatory bridge mixer, without pop-up with side spray set
 Batteria arcata a due fori con gruppo doccia lavello
 Batería de puente con rociador de cocina
 [max. 7 l/min.]



33 816 809
 Single-lever mixer
 Miscelatore monocomando
 Monomando
 [max. 7 l/min.]



19 825 809 + 27 718 809
 Two-hole lavatory bridge mixer, without pop-up with side spray set
 Batteria arcata a due fori con gruppo doccia lavello
 Batería de puente con rociador de cocina
 [max. 7 l/min.]

Fittings
Rubinetti
Griferías

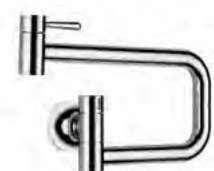

30 805 809 ^a
POT FILLER Cold-water valve
POT FILLER rubinetto acqua fredda
con bocca girevole
POT FILLER Válvula de agua fría
[max. 5,7 l/min.]

Accessories
Accessori
Complementos



82 434 809
Dispenser with rosette
Dispenser con rosetta
Dispensador con roseta



83 251 809 ^b
Hooks
Gancio
Gancho



10 713 809
AIR SWITCH Control button
AIR SWITCH pulsante di comando
AIR SWITCH botón de manejo



83 060 809 ^b
Towel bar
Asta portasciugamani
Barra colgador

^a A rough parts kit is required for this article. Item not available in finish 33. / Per questo articolo è necessario un kit di parti ad incasso. Articolo non disponibile nella superficie 33. / Se richiede un kit de partes empotradas para este artículo. Artículo no disponible en el acabado 33.

^b Item not available in finishes 93, 09 and 33. / Articolo non disponibile nelle superfici 93, 09 e 33. / Artículo no disponible en los acabados 93, 09 y 33.

Sinks and accessories Universal

Lavelli e accessori da cucina Serie neutra
Fregaderos y complementos Genérico



Single sink in polished stainless steel, available in the following dimensions:

Lavello singolo in acciaio inox lucido, Disponibile nelle seguenti misure:

Fregadero individual de acero inox pulido, disponible en las siguientes medidas:

- 18 x 40 cm: 38 180 003
- 34 x 40 cm: 38 340 003
- 40 x 40 cm: 38 400 003
- 45 x 40 cm: 38 450 003
- 50 x 40 cm: 38 500 003
- 55 x 40 cm: 38 550 003
- 65 x 40 cm: 38 650 003

85
Polished Stainless Steel
Acciaio inox lucido
Acero inox pulido



10 400 003 ^c

Pop-up waste and overflow closable by hand

Sistema piletta con troppo pieno può essere chiuso a mano

Juego de válvula semiautomática y rebosadero de cierre manual



10 410 003 ^c

Pop-up waste and overflow with electronic control

Sistema piletta con troppo pieno con controllo elettronico

Juego de válvula semiautomática y rebosadero electrónico



10 405 003 ^c

Pop-up waste and overflow with knob

Sistema piletta con troppo pieno con pomello

Juego de válvula semiautomática y rebosadero con tirador



10 415 003 ^{c, d}

Pop-up waste and overflow closable by hand

Sistema piletta con troppo pieno può essere chiuso a mano

Juego de válvula semiautomática y rebosadero de cierre manual



84 700 000
Cutting board
Tagliere
Tabla de cortar

^c Pop-up waste and overflow sets are only compatible with single sinks in Polished Stainless Steel. / Le pilette e troppopieno sono compatibili solo con i singoli lavelli in acciaio inox lucido. / Los juegos de desagüe y rebosadero solo son compatibles con fregaderos individuales en acero inox pulido.

^d This item is only compatible with item 38 180 003. / Questo articolo è compatibile soltanto con il 38 180 003. / Este artículo solo es compatible con el 38 180 003.



MEM

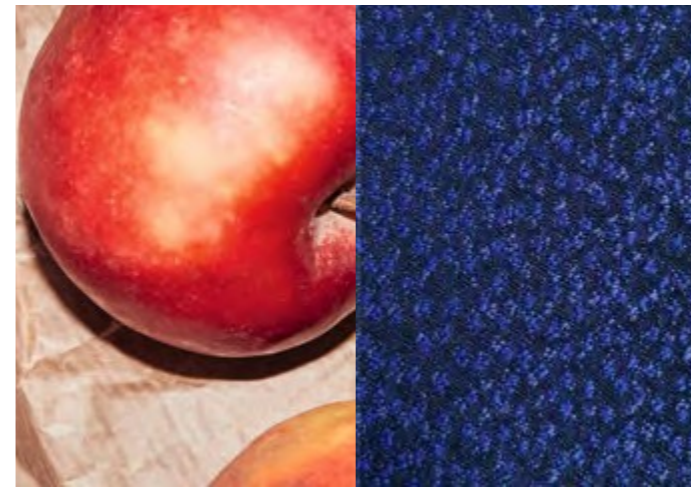



The Pure



EN Its clarity and originality are reminiscent of a natural spring. Its elementary form exudes great presence – yet is also unobtrusive.

IT Nella sua chiarezza e originalità, MEM ricorda una fonte d'acqua naturale. La forma elementare genera un ampio flusso a cascata.

ES Con su claridad y genuinidad, MEM recuerda a un manantial natural. Su forma elemental irradia una gran presencia, siendo discreta al mismo tiempo.



MEM CHAMPAGNE (22KT GOLD)

pure
elemental
confident

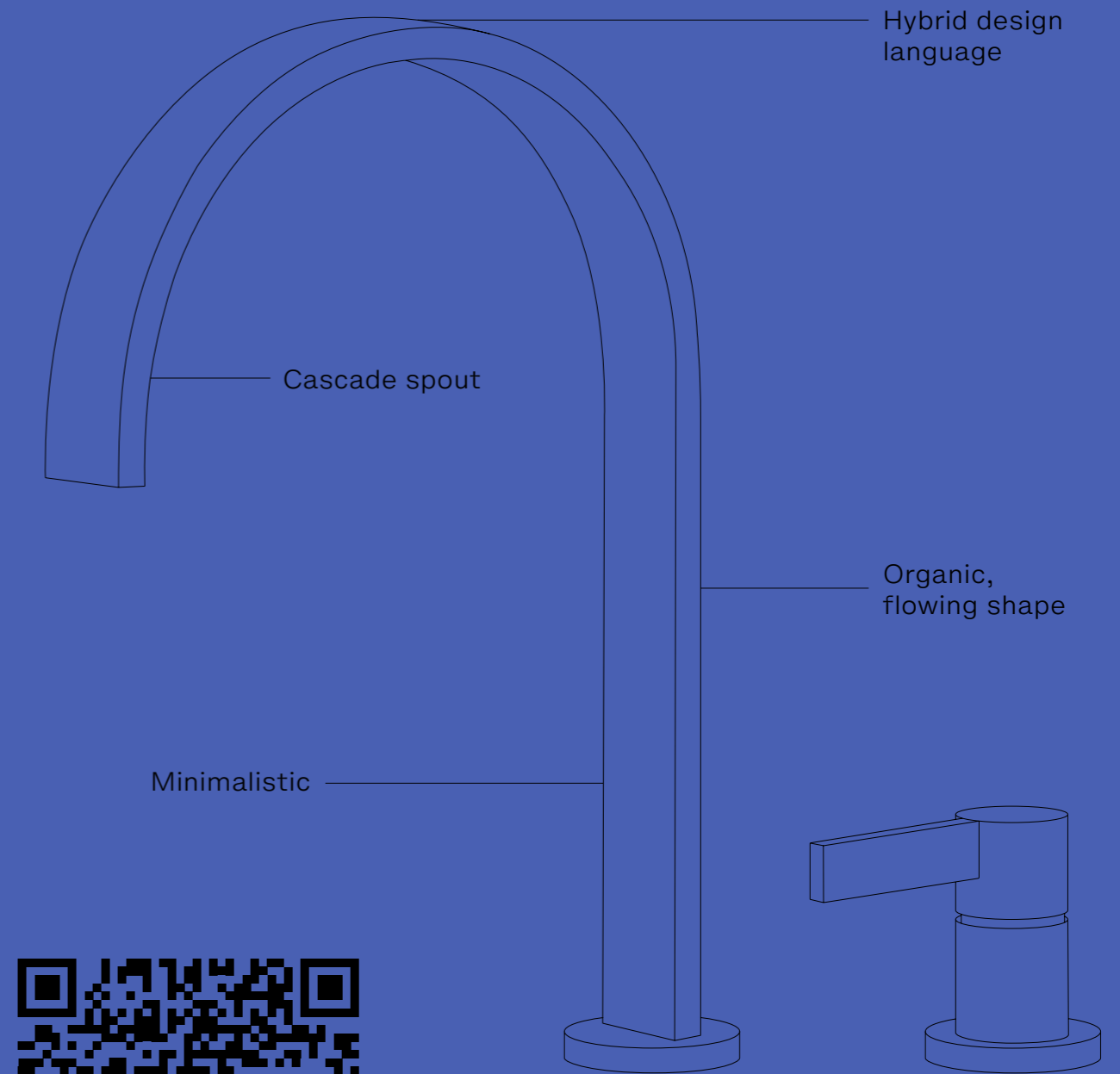



Urban Greenery

^{EN} For those who love nature as much as their city. Plants, earthy tones, and minimalistic shapes create a harmonious ensemble in this light-flooded kitchen.

^{IT} Per tutti coloro che amano la natura tanto quanto la città, piante, toni della terra e forme minimaliste creano un insieme armonioso nella cucina inondata di luce.

^{ES} Para todos aquellos que aman la naturaleza tanto como a la ciudad. Las plantas, los tonos terrosos y las formas minimalistas forman un conjunto armonioso en la cocina repleta de luz.



^{EN} For practical comfort in the designer kitchen: MEM two-hole with the rinsing spray on the side.

^{IT} Per un comfort pratico nella cucina di design: MEM a due fori in combinazione con la doccetta laterale sul piano.

^{ES} Para un práctico confort en la cocina de diseño: MEM de dos orificios en combinación con juego de ducha lateral.



Elemental Virtuosity

^{EN} The uninterrupted lines of MEM embody a constant flow, reflecting its particular design language. The integrated aerator provides a gentle flow that is enriched by air.

^{IT} Le linee ininterrotte di MEM incarnano un flusso costante e riflettono il loro speciale linguaggio di design. L'aeratore integrato fornisce un getto morbido e arricchito d'aria.

^{ES} Las líneas ininterrumpidas en MEM plasman un flujo continuo y reflejan su lenguaje formal especial. Un mezclador integrado ofrece un chorro suave enriquecido con aire.



organic fabrics
black terrazzo
screed
steel & walnut wood



Materials





MEM

Selected Products

EN Discover the MEM product portfolio: the BAR TAP for a refreshing glass of water whenever you like, as well as various other accessories for your kitchen.

IT Scoprite la gamma di prodotti MEM: il BAR TAP arricchisce la vasta selezione di accessori per la vostra cucina.

ES Descubra la gama de productos de MEM: BAR TAP, para tomar un refrescante vaso de agua de vez en cuando, así como más complementos para su cocina.

Product Information
 Informazioni sui prodotti
 Información de producto

^{EN} Excerpt from the product range.
 More detailed information can be obtained from your dealer. Due to the printing technique used here, the colours shown may vary from the true colour of the actual finish.

^{IT} Estratto dalla gamma completa prodotti.
 Il Vostro rivenditore specializzato sarà lieto di fornirvi maggiori informazioni. Per motivi tecnici di stampa non possiamo garantire la fedeltà dei colori qui riprodotti.

^{ES} Extracto del programa de productos.
 Si desea más información consulte con su comercio habitual. Los acabados reproducidos en el presente catálogo no son vinculantes por razones de impresión.

Finishes for fittings
 Finiture rubinetteria
 Acabados grifería



00
 Chrome
 Cromato
 Cromo



93
 Brushed Chrome
 Cromo spazzolato
 Cromo cepillado



08
 Platinum
 Platinato
 Platino

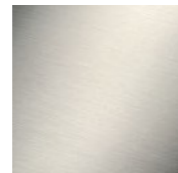

06
 Brushed Platinum
 Platinato spazzolato
 Platino cepillado



47
 Champagne (22kt Gold)
 Champagne (Oro 22k)
 Champagne (Oro 22k)

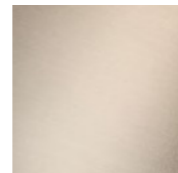

46
 Brushed Champagne
 (22kt Gold)
 Champagne spazzolato
 (Oro 22k)
 Champagne cepillado
 (Oro 22k)

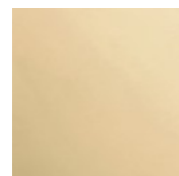

09
 Durabress (23kt Gold)
 Ottone (Oro 23k)
 Latón (Oro 23k)

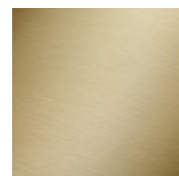

28
 Brushed Durabress
 (23kt Gold)
 Ottone spazzolato
 (Oro 23k)
 Latón cepillado (Oro 23k)



19
 Dark Chrome
 Dark Chrome
 Dark Chrome

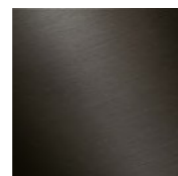

99
 Brushed Dark Platinum
 Dark Platinum spazzolato
 Dark Platinum cepillado



33
 Matte Black
 Nero opaco
 Negro mate

Fittings
 Rubinetti
 Griferías



33 805 682
 BAR TAP Single-lever mixer
 BAR TAP Miscelatore monocomando
 BAR TAP Monomando
 [max. 6,3 l/min.]



32 815 682 + 27 799 970 ^a
 Two-hole mixer with individual flanges with Profi spray set
 Miscelatore monocomando a due fori con rosette separate con gruppo doccetta professionale
 Batería monomando de dos orificios con rosetas individuales con rociador de cocina profesional
 [max. 6,3 l/min.]



33 800 682
 Single-lever mixer
 Miscelatore monocomando
 Monomando
 [max. 6,3 l/min.]



33 815 682
 Single-lever mixer
 Miscelatore monocomando
 Monomando
 [max. 6,3 l/min.]



32 815 682
 Two-hole mixer with individual rosettes
 Miscelatore monocomando a due fori con rosette separate
 Batería monomando de dos orificios con rosetas individuales
 [max. 6,3 l/min.]



32 815 682 + 27 731 970
 Two-hole mixer with individual flanges with side spray set
 Miscelatore monocomando a due fori con rosette separate con gruppo doccetta lavello
 Batería monomando de dos orificios con rosetas individuales con rociador de cocina
 [max. 6,3 l/min.]

^a Item not available in finishes 47, 46, 09, 28 and 33. / Articolo non disponibile nelle superfici 47, 46, 09, 28 e 33. / Artículo no disponible en los acabados 47, 46, 09, 28 y 33.

Accessories
 Accessori
 Complementos

Sinks and accessories Universal
 Lavelli e accessori da cucina Serie neutra
 Fregaderos y complementos Genérico



82 424 970
 Dispenser without rosette
 Dispenser senza rosetta
 Dispensador sin roseta



83 060 979 ^b
 Towel bar
 Asta portasciugamani
 Barra colgador



10 713 970
 AIR SWITCH Control button
 AIR SWITCH pulsante di comando
 AIR SWITCH botón de manejo



83 080 979 ^b
 Towel bar
 Asta portasciugamani
 Barra colgador



10 712 970
 Strainer waste with control handle
 Comando piletta ad eccentrico con manopola
 Accionamiento excéntrico manual con maneta de control giratoria



12 715 970
 Cover for tap hole
 Copertura per foro di montaggio
 Tapón de orificio



83 251 220
 Hooks
 Gancio
 Gancho



Single sink in polished stainless steel, available in the following dimensions:
 Lavello singolo in acciaio inox lucido, Disponibile nelle seguenti misure:
 Fregadero individual de acero inox pulido, disponible en las siguientes medidas:
 18 x 40 cm: 38 180 003
 34 x 40 cm: 38 340 003
 40 x 40 cm: 38 400 003
 45 x 40 cm: 38 450 003
 50 x 40 cm: 38 500 003
 55 x 40 cm: 38 550 003
 65 x 40 cm: 38 650 003

85
 Polished Stainless Steel
 Acciaio inox lucido
 Acero inox pulido



10 400 003 ^c
 Pop-up waste and overflow closable by hand
 Sistema piletta con troppo pieno può essere chiuso a mano
 Juego de válvula semiautomática y rebosadero de cierre manual



10 410 003 ^c
 Pop-up waste and overflow with electronic control
 Sistema piletta con troppo pieno con controllo elettronico
 Juego de válvula semiautomática y rebosadero electrónico



10 405 003 ^c
 Pop-up waste and overflow with knob
 Sistema piletta con troppo pieno con pomello
 Juego de válvula semiautomática y rebosadero con tirador



10 415 003 ^{c, d}
 Pop-up waste and overflow closable by hand
 Sistema piletta con troppo pieno può essere chiuso a mano
 Juego de válvula semiautomática y rebosadero de cierre manual



84 700 000
 Cutting board
 Tagliere
 Tabla de cortar

^b Item not available in finishes 08, 09 and 99. / Articolo non disponibile nelle superfici 08, 09 e 99. / Artículo no disponible en los acabados 08, 09 y 99.

^c Pop-up waste and overflow sets are only compatible with single sinks in Polished Stainless Steel. / Le pilette e troppopieno sono compatibili solo con i singoli lavelli in acciaio inox lucido. / Los juegos de desagüe y rebosadero solo son compatibles con fregaderos individuales en acero inox pulido.
^d This item is only compatible with item 38 180 003. / Questo articolo è compatibile soltanto con il 38 180 003. / Este artículo solo es compatible con el 38 180 003.



META



SQUARE





^{EN} The slender geometric shape is what makes META SQUARE so versatile. The double bent spout and cylindrical elements are typical features.

^{IT} La sua forma elegante e geometrica è ciò che rende META SQUARE così versatile. Le caratteristiche sono la bocca a doppia curvatura e gli elementi di forma cilindrica.

^{ES} Su forma esbelta y geométrica aporta a META SQUARE una gran versatilidad. La caracterizan el caño de salida de curvatura doble y sus elementos formales cilíndricos.



The Versatile



META SQUARE BRUSHED CHAMPAGNE (22KT GOLD)

versatile
individual
refined

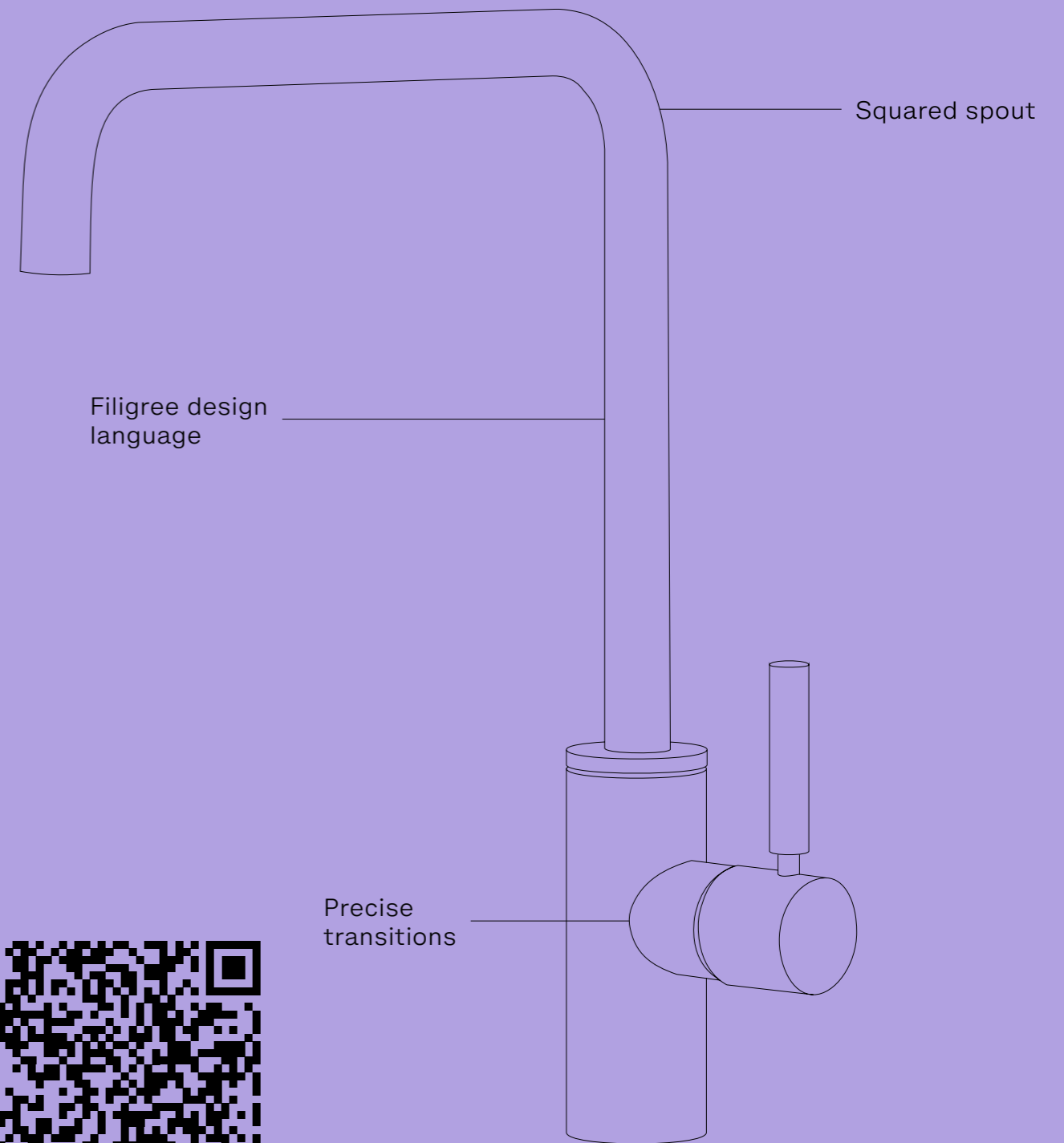



Cosmopolitan Fusion

EN META SQUARE in Matte Black embarks on an experimental liaison with pink kitchen door fronts and top, with a splashback in dark green terrazzo.

IT META SQUARE in Nero opaco incontra una liaison sperimentale tra il piano rosa e la parete posteriore realizzata in Terrazzo verde scuro.

ES META SQUARE en Negro mate forma una alianza experimental de frentes en rosa y paneles traseros en Terrazzo verde oscuro.



^{EN} With the finish in Brushed Champagne (22kt Gold), META SQUARE brings a cosmopolitan flair into the kitchen.

^{IT} Nella finitura Champagne spazzolato (Oro 22 ct), META SQUARE porta un tocco cosmopolita in cucina.

^{ES} En el acabado Champagne cepillado (Oro 22k), META SQUARE aporta un aire cosmopolita a la cocina.

A Kitchen – As Individual As You



EN META SQUARE also provides functionally for its versatility. The BAR TAP and easy-to-use rinsing spray set are the perfect additions to the single-lever mixer.

IT Dal punto di vista funzionale, META SQUARE convince anche per la sua versatilità. Il BAR TAP e il comodo gruppo doccia da piano sono il complemento perfetto per il miscelatore monocomando.

ES META SQUARE también convence en cuanto a funcionalidad por su versatilidad. BAR TAP y el confortable juego de grifo de cocina con chorro de ducha son el complemento perfecto para el mezclador monomando.

stainless steel
green terrazzo
lush rose
matte black

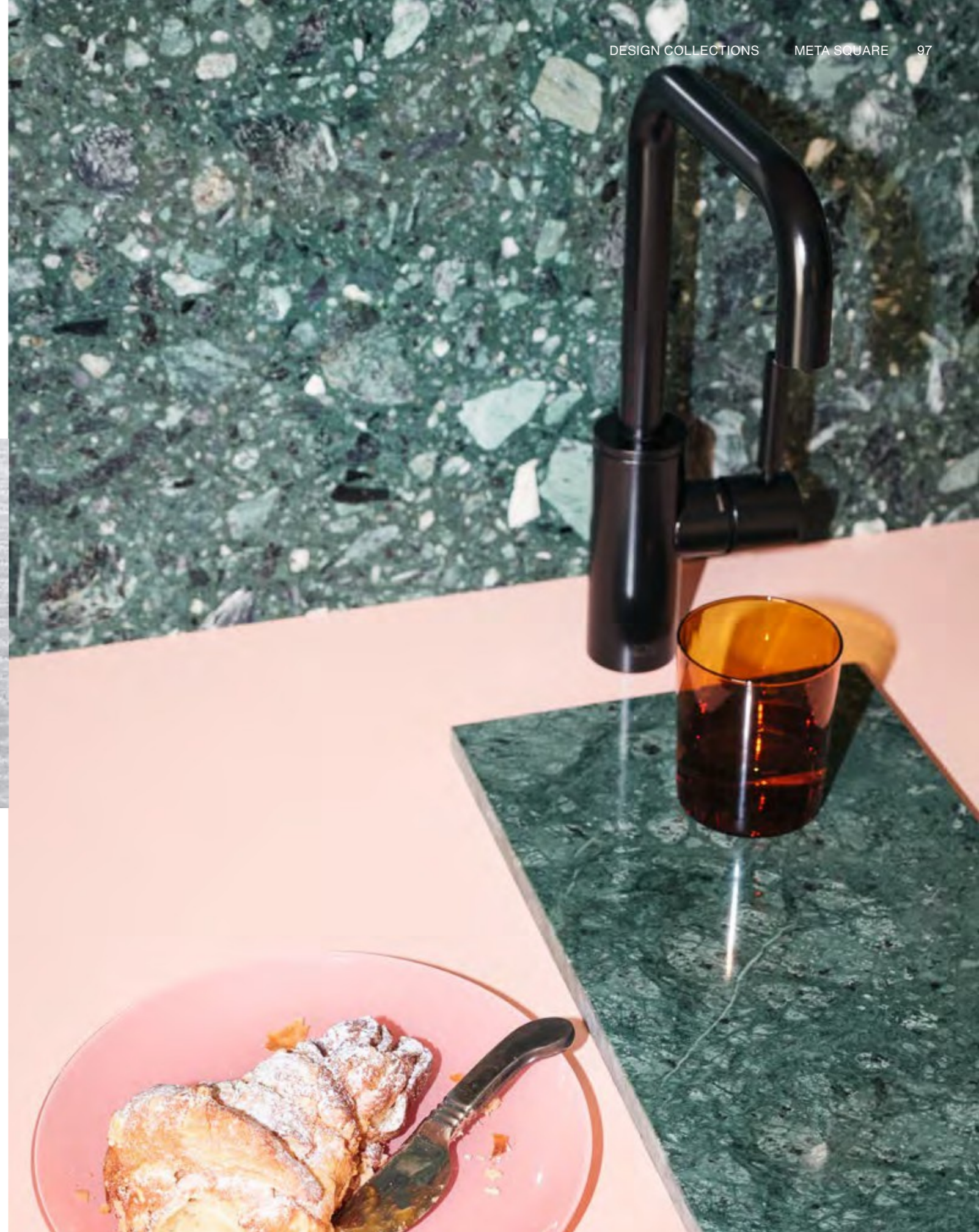
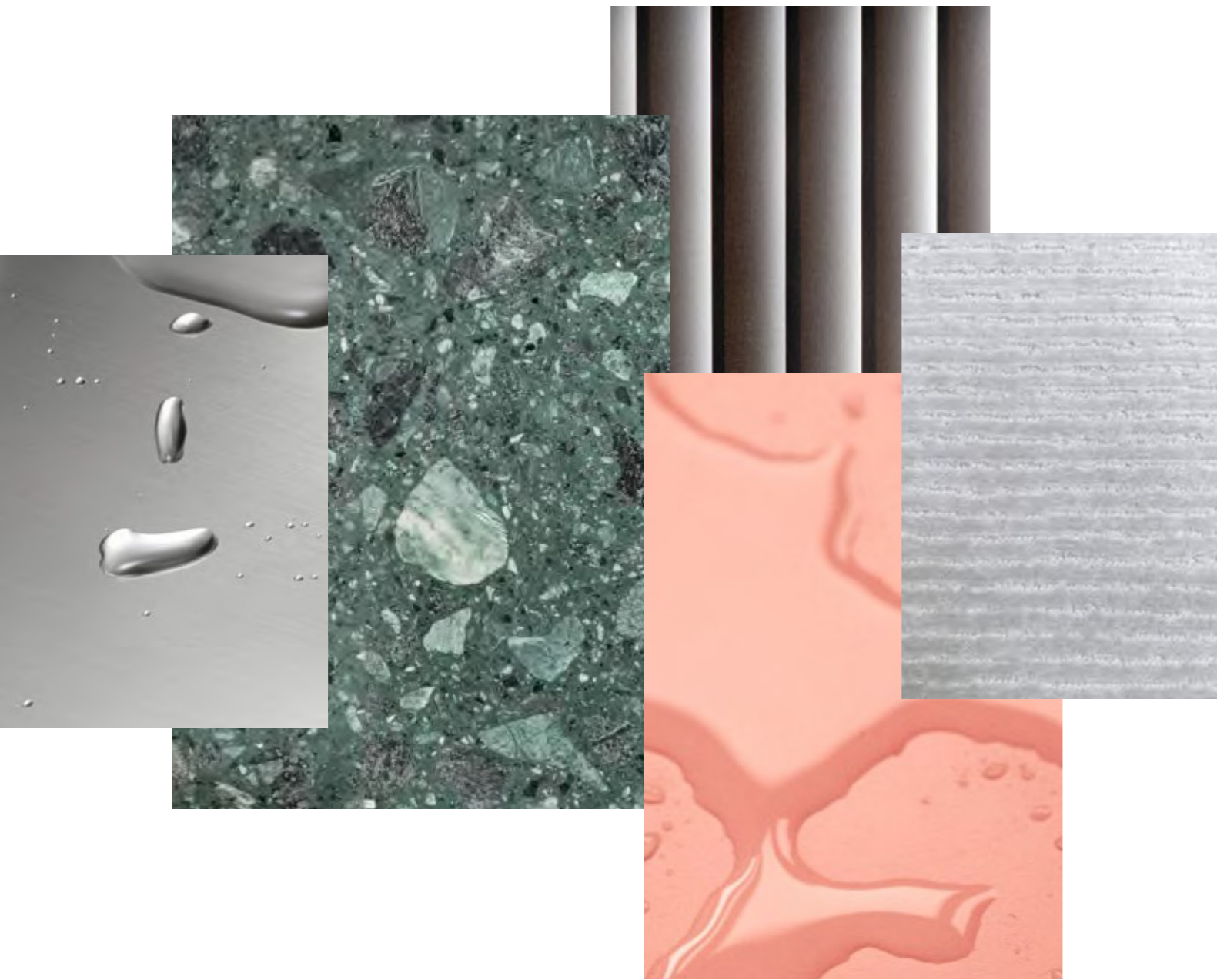

Materials



EN The META SQUARE series offers you design freedom: it includes the classic single-lever mixer as well as the extended version with the PULL DOWN function and spray flow.

IT La serie META SQUARE vi offre libertà di progettazione: oltre al classico miscelatore monocomando, esiste anche la versione allungabile con funzione PULL-DOWN e doccia estraibile.

ES La serie META SQUARE le ofrece libertad de diseño: además de la versión monomando clásico, entre otras, se ofrece una variante extraíble como PULL-DOWN y chorro de ducha.

META SQUARE Selected Products

Product Information
 Informazioni sui prodotti
 Información de producto

^{EN} Excerpt from the product range.
 More detailed information can be obtained from your dealer. Due to the printing technique used here, the colours shown may vary from the true colour of the actual finish.

^{IT} Estratto dalla gamma completa prodotti.
 Il Vostro rivenditore specializzato sarà lieto di fornirvi maggiori informazioni. Per motivi tecnici di stampa non possiamo garantire la fedeltà dei colori qui riprodotti.

^{ES} Extracto del programa de productos.
 Si desea más información consulte con su comercio habitual. Los acabados reproducidos en el presente catálogo no son vinculantes por razones de impresión.

Finishes for fittings
 Finiture rubinetteria
 Acabados grifería



00
 Chrome
 Cromato
 Cromo



93
 Brushed Chrome
 Cromo spazzolato
 Cromo cepillado



08
 Platinum
 Platinato
 Platino



06
 Brushed Platinum
 Platinato spazzolato
 Platino cepillado



47
 Champagne (22kt Gold)
 Champagne (Oro 22k)
 Champagne (Oro 22k)

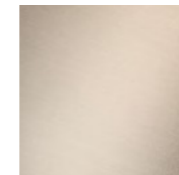

46
 Brushed Champagne
 (22kt Gold)
 Champagne spazzolato
 (Oro 22k)
 Champagne cepillado
 (Oro 22k)

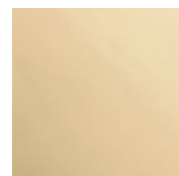

09
 Durabress (23kt Gold)
 Ottone (Oro 23k)
 Latón (Oro 23k)

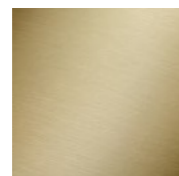

28
 Brushed Durabress
 (23kt Gold)
 Ottone spazzolato
 (Oro 23k)
 Latón cepillado (Oro 23k)



19
 Dark Chrome
 Dark Chrome
 Dark Chrome



99
 Brushed Dark Platinum
 Dark Platinum spazzolato
 Dark Platinum cepillado



33
 Matte Black
 Nero opaco
 Negro mate

Fittings
 Rubinetti
 Griferías



33 870 861
 Single-lever mixer Pull-down with spray function
 Miscelatore monocomando ad estrazione Pull-down con funzione doccia
 Monomando Pull-down con función de chorro
 [max. 10,4 l/min.]



33 826 861 + 27 731 970
 Single-lever mixer with side spray set
 Miscelatore monocomando con gruppo doccia livello
 Monomando con rociador de cocina
 [max. 8 l/min.]



17 861 625 ^a
 HOT & COLD WATER DISPENSER
 HOT & COLD WATER DISPENSER
 HOT & COLD WATER DISPENSER
 [max. 2 l/min.]

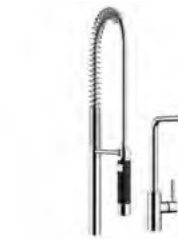

33 826 861 + 27 799 970 ^b
 Single-lever mixer with Profi spray set
 Miscelatore monocomando con gruppo doccia professionale
 Monomando con rociador de cocina profesional
 [max. 8 l/min.]



33 805 861
 BAR TAP Single-lever mixer
 BAR TAP Miscelatore monocomando
 BAR TAP Monomando
 [max. 8 l/min.]



32 815 861
 Two-hole mixer with individual rosettes
 Miscelatore monocomando a due fori con rosette separate
 Batería monomando de dos orificios con rosetas individuales
 [max. 8 l/min.]



33 800 861
 Single-lever mixer
 Miscelatore monocomando
 Monomando
 [max. 8 l/min.]



32 815 861 + 27 731 970
 Two-hole mixer with individual flanges with side spray set
 Miscelatore monocomando a due fori con rosette separate con gruppo doccia livello
 Batería monomando de dos orificios con rosetas individuales con rociador de cocina
 [max. 8 l/min.]



33 815 861
 Single-lever mixer
 Miscelatore monocomando
 Monomando
 [max. 8 l/min.]



32 815 861 + 27 799 970 ^b
 Two-hole mixer with individual flanges with Profi spray set
 Miscelatore monocomando a due fori con rosette separate con gruppo doccia professionale
 Batería monomando de dos orificios con rosetas individuales con rociador de cocina profesional
 [max. 8 l/min.]

^a You need the corresponding system components for this product. / Per questo prodotto, sono necessari componenti di sistema appropriati. / Para este producto necesita los componentes de sistema adecuados.

^b Item not available in finishes 47, 46, 09, 28 and 33. / Articolo non disponibile nelle superfici 47, 46, 09, 28 e 33. / Artículo no disponible en los acabados 47, 46, 09, 28 y 33.

Fittings
Rubinetti
Griferías



30 805 875 ^c
POT FILLER Cold-water valve
POT FILLER rubinetto acqua fredda
con bocca girevole
POT FILLER Válvula de agua fría
[max. 5,7 l/min.]

Accessories
Accessori
Complementos



82 424 970
Dispenser without rosette
Pompje zonder rozet
Distributeur sans rosace



83 251 220
Hooks
Gancio
Gancho



10 713 970
AIR SWITCH Control button
AIR SWITCH pulsante di comando
AIR SWITCH botón de manejo



83 060 979 ^d
Towel bar
Asta portasciugamani
Barra colgador



10 712 970
Strainer waste with control handle
Comando piletta ad eccentrico con
manopola con manopola
Accionamiento excéntrico manual con
maneta de control giratoria

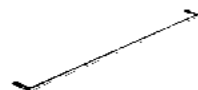

83 080 979 ^d
Towel bar
Asta portasciugamani
Barra colgador



12 715 970
Cover for tap hole
Kraangatafdekking
Cache pour percement
de robinetterie

^c A rough parts kit is required for this article. Item not available in finish 33. / Per questo articolo è necessario un kit di parti ad incasso. Articolo non disponibile nella superficie 33. / Se richiede un kit de partes empotradas para este artículo. Artículo no disponible en el acabado 33.
^d Item not available in finishes 08, 09 and 99. / Articolo non disponibile nelle superfici 08, 09 e 99. / Artículo no disponible en los acabados 08, 09 y 99.

Sinks and accessories Universal

Lavelli e accessori da cucina Serie neutra
Fregaderos y complementos Genérico



Single sink in polished stainless steel, available in the following dimensions:

Lavello singolo in acciaio inox lucido, Disponibile nelle seguenti misure:

Fregadero individual de acero inox pulido, disponible en las siguientes medidas:

- 18 x 40 cm: 38 180 003
- 34 x 40 cm: 38 340 003
- 40 x 40 cm: 38 400 003
- 45 x 40 cm: 38 450 003
- 50 x 40 cm: 38 500 003
- 55 x 40 cm: 38 550 003
- 65 x 40 cm: 38 650 003

85
Polished Stainless Steel
Acciaio inox lucido
Acero inox pulido



10 400 003 ^e
Pop-up waste and overflow closable by hand
Sistema piletta con troppo pieno può essere chiuso a mano
Juego de válvula semiautomática y rebosadero de cierre manual



10 410 003 ^e
Pop-up waste and overflow with electronic control
Sistema piletta con troppo pieno con controllo elettronico
Juego de válvula semiautomática y rebosadero electrónico



10 405 003 ^e
Pop-up waste and overflow with knob
Sistema piletta con troppo pieno con pomello
Juego de válvula semiautomática y rebosadero con tirador



10 415 003 ^{e, f}
Pop-up waste and overflow closable by hand
Sistema piletta con troppo pieno può essere chiuso a mano
Juego de válvula semiautomática y rebosadero de cierre manual



84 700 000
Cutting board
Tagliere
Tabla de cortar

^e Pop-up waste and overflow sets are only compatible with single sinks in Polished Stainless Steel. / Le pilette e troppopieno sono compatibili solo con i singoli lavelli in acciaio inox lucido. / Los juegos de desagüe y rebosadero solo son compatibles con fregaderos individuales en acero inox pulido.
^f This item is only compatible with item 38 180 003. / Questo articolo è compatibile soltanto con il 38 180 003. / Este artículo solo es compatible con el 38 180 003.



TARA

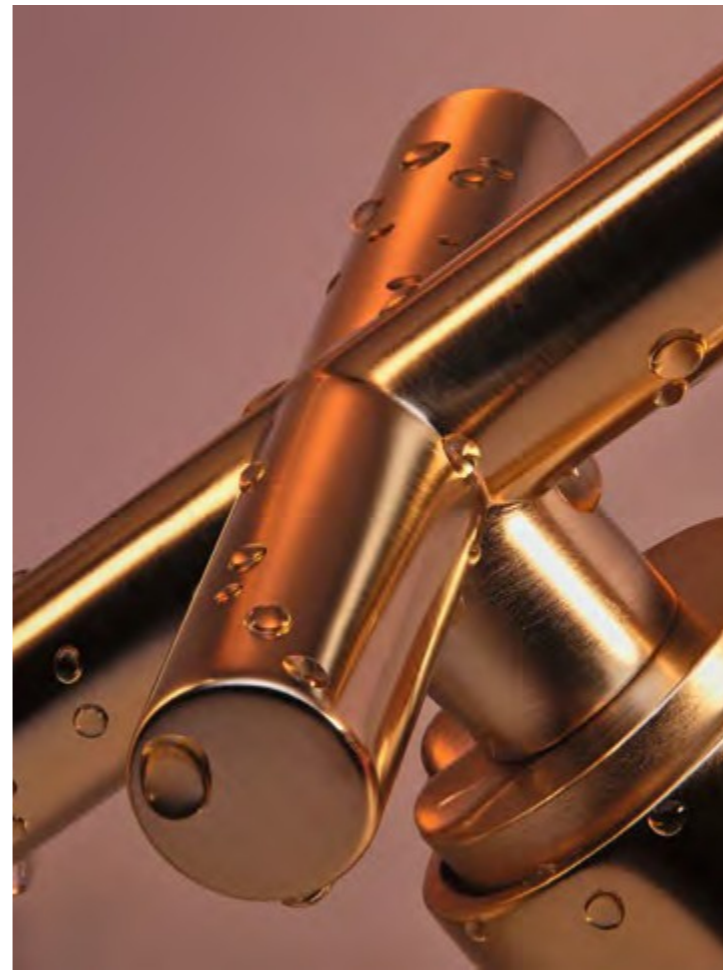



EN TARA is a modern archetype. Its iconic shape: the perfect symmetry, unbeatable precision and timeless modernity. A design object that is always contemporary.

IT TARA è un archetipo moderno. La sua forma iconica: di simmetria ideale, spiccata precisione e modernità senza tempo, un oggetto di design che non perde mai la sua attualità.

ES TARA es un arquetipo moderno. Su forma icónica: de simetría ideal, marcada precisión y modernidad atemporal. Un objeto de diseño que nunca pierde en actualidad.



The Archetype



TARA DURABRASS (23KT GOLD)

archetypal
modern
perfected

180° arched spout

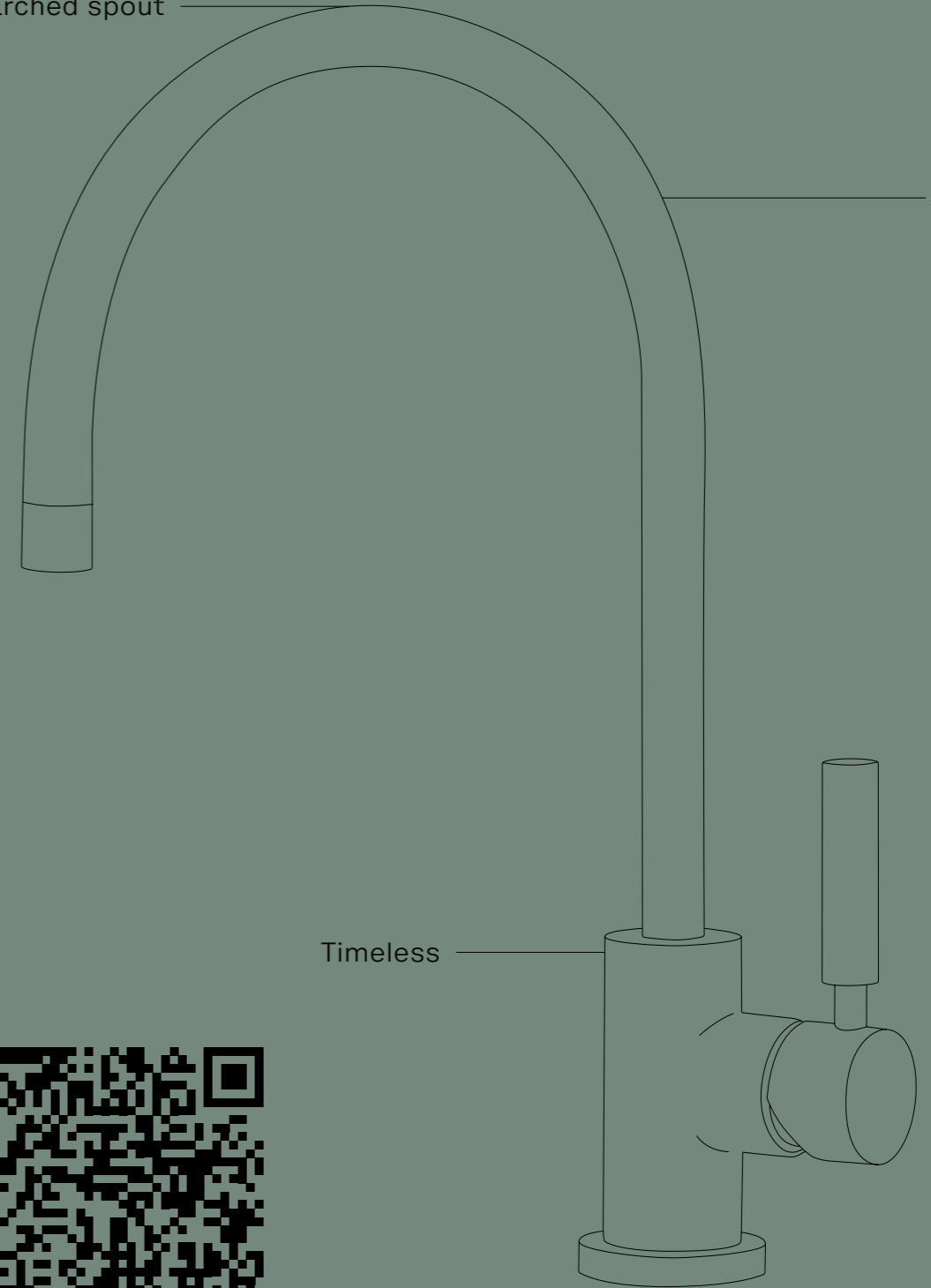

Iconic design

Timeless



Find out more about TARA at dornbracht.com/tara-kitchen



Timeless Comfort

EN An inviting ambience, inspired by the American style of the open kitchen that is full of life: the design classic TARA blends naturally with combinations of classic and modern elements.

HCWD not available in Germany

IT Ispirata allo stile americano della cucina a vista, piena di vita, crea un'atmosfera accogliente: il design classico TARA si fonde naturalmente nella combinazione di elementi classici e moderni.

HCWD non disponibile in Germania

ES Inspirado en el estilo americano de cocina abierta, el resultado es un ambiente acogedor: el clásico del diseño TARA encaja naturalmente en la combinación de elementos clásicos y modernos.

HCWD no disponible en Alemania



^{EN} As a classic, TARA in the Brushed Champagne (22kt Gold) finish combines design with timeless elegance.

^{IT} Come classico, TARA combina un design collaudato con standard senza tempo nella finitura Champagne spazzolato (Oro 22 ct).

^{ES} Como clásico, TARA combina un acreditado diseño con pretensiones atemporales en su acabado Champagne cepillado (Oro 22k).

Perfect Kitchen Feeling



EN Stylistic confidence with the maximum comfort: the POT FILLER allows the user to fill it directly by the hob, while the Air Switch is an elegant solution for grinding waste.

IT Un senso di praticità unito al massimo livello di comfort: Il POT FILLER consente un riempimento immediato direttamente sul punto di cottura, mentre il tasto Air Switch offre un'elegante soluzione per l'attivazione del tritarifiuti.

ES Estilo seguro con máximo confort: POT FILLER permite llenar ollas y recipientes directamente en la placa de cocina, y Air Switch ofrece una solución elegante para la trituradora de basura.



lime plaster
calacatta oro marble
stained oak & linen
travertine tiles



Materials

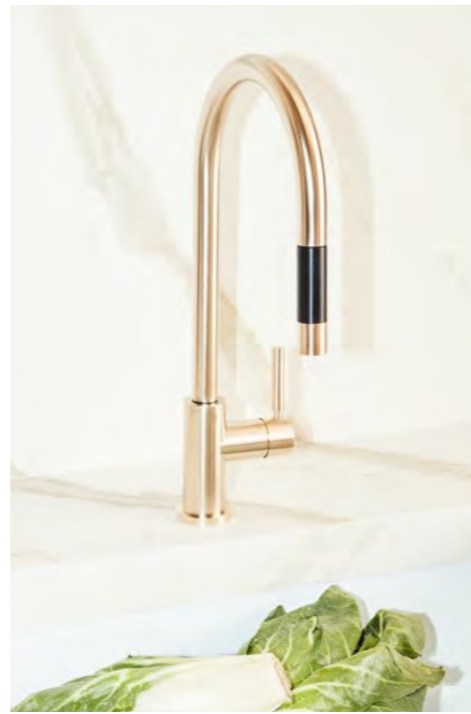

EN TARA is style-defining in the most diverse interiors, and offers you a curated selection of finishes and an exceptional depth of range. Discover the inspirational variety of this classic's series.

HCWD not available in Germany

IT TARA definisce lo stile in un'ampia varietà di interni grazie ad un'accurata selezione di finiture. Scoprite le varietà ispiratrici di questo grande classico.

HCWD non disponibile in Germania

ES TARA marca estilo en los interiores más versátiles y le ofrece una gran selección de acabados y una gama especialmente amplia. Descubra la gran variedad inspiradora de este clásico.

HCWD no disponible en Alemania



TARA

Selected Products

Product Information
 Informazioni sui prodotti
 Información de producto

^{EN} Excerpt from the product range.
 More detailed information can be obtained from your dealer. Due to the printing technique used here, the colours shown may vary from the true colour of the actual finish.

^{IT} Estratto dalla gamma completa prodotti.
 Il Vostro rivenditore specializzato sarà lieto di fornirvi maggiori informazioni. Per motivi tecnici di stampa non possiamo garantire la fedeltà dei colori qui riprodotti.

^{ES} Extracto del programa de productos.
 Si desea más información consulte con su comercio habitual. Los acabados reproducidos en el presente catálogo no son vinculantes por razones de impresión.

Finishes for fittings
 Finiture rubinetteria
 Acabados grifería



00
 Chrome
 Cromato
 Cromo

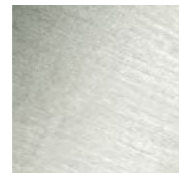

93
 Brushed Chrome
 Cromo spazzolato
 Cromo cepillado



08
 Platinum
 Platinato
 Platino

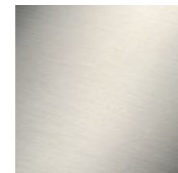

06
 Brushed Platinum
 Platinato spazzolato
 Platino cepillado



47
 Champagne (22kt Gold)
 Champagne (Oro 22k)
 Champagne (Oro 22k)

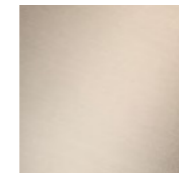

46
 Brushed Champagne
 (22kt Gold)
 Champagne spazzolato
 (Oro 22k)
 Champagne cepillado
 (Oro 22k)

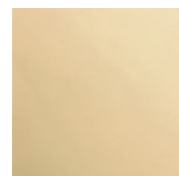

09
 Durabass (23kt Gold)
 Ottone (Oro 23k)
 Latón (Oro 23k)

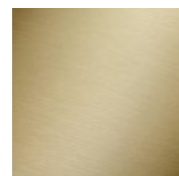

28
 Brushed Durabass
 (23kt Gold)
 Ottone spazzolato
 (Oro 23k)
 Latón cepillado (Oro 23k)



19
 Dark Chrome
 Dark Chrome
 Dark Chrome

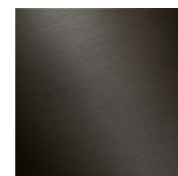

99
 Brushed Dark Platinum
 Dark Platinum spazzolato
 Dark Platinum cepillado



33
 Matte Black
 Nero opaco
 Negro mate

Fittings
 Rubinetti
 Griferías



33 870 888
 Single-lever mixer Pull-down with spray function
 Miscelatore monocomando ad estrazione Pull-down con funzione doccia
 Monomando Pull-down con función de chorro
 [max. 10,4 l/min.]



33 815 888
 Single-lever mixer
 Miscelatore monocomando
 Monomando
 [max. 7 l/min.]



33 880 888^a
 Profi single-lever mixer
 Miscelatore monocomando professionale
 Monomando Profi
 [max. 7 l/min.]



33 826 888 + 27 721 970
 Single-lever mixer with side spray set
 Miscelatore monocomando con gruppo doccia lavello
 Monomando con rociador de cocina
 [max. 7 l/min.]



17 861 888^b
 HOT & COLD WATER DISPENSER
 HOT & COLD WATER DISPENSER
 HOT & COLD WATER DISPENSER
 [max. 2 l/min.]



33 826 888 + 27 789 970^a
 Single-lever mixer with Profi spray set
 Miscelatore monocomando con gruppo doccia professionale
 Monomando con rociador de cocina profesional
 [max. 7 l/min.]



33 805 888
 BAR TAP Single-lever mixer
 BAR TAP Miscelatore monocomando
 BAR TAP Monomando
 [max. 8,3 l/min.]



32 815 888
 Two-hole mixer with individual rosettes
 Miscelatore monocomando a due fori con rosette separate
 Batería monomando de dos orificios con rosetas individuales
 [max. 8,3 l/min.]



33 800 888
 Single-lever mixer
 Miscelatore monocomando
 Monomando
 [max. 7 l/min.]



32 815 888 + 27 721 970
 Two-hole mixer with individual flanges with side spray set
 Miscelatore monocomando a due fori con rosette separate con gruppo doccia lavello
 Batería monomando de dos orificios con rosetas individuales con rociador de cocina
 [max. 8,3 l/min.]

^a Item not available in finishes 47, 46, 09, 28 and 33. / Articolo non disponibile nelle superfici 47, 46, 09, 28 e 33. / Artículo no disponible en los acabados 47, 46, 09, 28 y 33.

^b You need the corresponding system components for this product. This product is not available in Germany. / Per questo prodotto, sono necessari componenti di sistema appropriati. Questo prodotto non è disponibile in Germania. / Para este producto necesita los componentes de sistema adecuados. Este producto no puede solicitarse en Alemania.

Fittings
Rubinetti
Griferías

Accessories
Accessori
Complementos



32 815 888 + 27 789 970[°]
Two-hole mixer with individual flanges with Profi spray set
Miscelatore monocomando a due fori con rosette separate con gruppo doccetta professionale
Batería monomando de dos orificios con rosetas individuales con rociador de cocina profesional
[max. 8,3 l/min.]



31 151 892[°]
Wall-mounted bridge mixer with extending spout
Batería arcata montaggio a muro con bocca estendibile
Batería mural de puente con caño extraíble
[max. 8,3 l/min.]



22 815 892
Single-hole mixer
Miscelatore monoforo
Grifo mezclador con un orificio
[max. 7 l/min.]

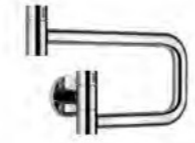

30 805 875[°]
POT FILLER Cold-water valve
POT FILLER rubinetto acqua fredda con bocca girevole
POT FILLER rubinetto acqua fredda con bocca girevole
[max. 5,7 l/min.]



20 815 892
Three-hole mixer
Batería tre fori
Batería americana
[max. 7 l/min.]



20 815 892 + 27 721 970
Three-hole mixer with side spray set
3-gats mengkraan met spoeldouchegarnituur
Mélangeur à trois trous avec douchette extractible
[max. 7 l/min.]



20 815 892 + 27 789 970[°]
Three-hole mixer with Profi spray set
Batería tre fori con gruppo doccetta professionale
Batería americana con rociador de cocina profesional
[max. 7 l/min.]



82 444 970
Dispenser with rosette
Dispenser con rosetta
Dispensador con roseta



83 256 979[†]
Hooks in two parts
Gancio in due parti
Gancho de dos piezas



10 713 970
AIR SWITCH Control button
AIR SWITCH pulsante di comando
AIR SWITCH botón de manejo



83 251 892
Hooks
Gancio
Gancho



10 710 970
Strainer waste with control handle
Comando piletta ad eccentrico con manopola
Accionamiento excéntrico manual con maneta de control giratoria



83 045 892[‡]
Towel bar
Asta portasciugamani
Barra colgador



12 715 970
Cover for tap hole
Copertura per foro di montaggio
Tapón de orificio



83 060 892[‡]
Towel bar
Asta portasciugamani
Barra colgador



83 251 979[†]
Hooks
Gancio
Gancho



83 080 892[‡]
Towel bar
Asta portasciugamani
Barra colgador

[°] Item not available in finishes 47, 46, 09, 28 and 33. / Articolo non disponibile nelle superfici 47, 46, 09, 28 e 33. / Artículo no disponible en los acabados 47, 46, 09, 28 y 33.

[†] Item not available in finish 33. / Articolo non disponibile nella superficie 33. / Artículo no disponible en el acabado 33.

[‡] A rough parts kit is required for this article. Item not available in finish 33. / Per questo articolo è necessario un kit di parti ad incasso.

Articolo non disponibile nella superficie 33. / Se requiere un kit de partes empotradas para este artículo. Artículo no disponible en el acabado 33.

[†] Item not available in finishes 08 and 09. / Articolo non disponibile nelle superfici 08 e 09. / Artículo no disponible en los acabados 08 y 09.

[‡] Item not available in Finish 09. / Articolo non disponibile nella superficie 09. / Artículo no disponible en el acabado 09.



Single sink in polished stainless steel, available in the following dimensions:

Lavello singolo in acciaio inox lucido, Disponibile nelle seguenti misure:

Fregadero individual de acero inox pulido, disponible en las siguientes medidas:

18 x 40 cm: 38 180 003
 34 x 40 cm: 38 340 003
 40 x 40 cm: 38 400 003
 45 x 40 cm: 38 450 003
 50 x 40 cm: 38 500 003
 55 x 40 cm: 38 550 003
 65 x 40 cm: 38 650 003

85
 Polished Stainless Steel
 Acciaio inox lucido
 Acero inox pulido



10 400 003^h

Pop-up waste and overflow closable by hand

Sistema piletta con troppo pieno può essere chiuso a mano

Juego de válvula semiautomática y rebosadero de cierre manual



10 410 003^h

Pop-up waste and overflow with electronic control

Sistema piletta con troppo pieno con controllo elettronico

Juego de válvula semiautomática y rebosadero electrónico



10 405 003^h

Pop-up waste and overflow with knob

Sistema piletta con troppo pieno con pomello

Juego de válvula semiautomática y rebosadero con tirador



10 415 003^{h, i}

Pop-up waste and overflow closable by hand

Sistema piletta con troppo pieno può essere chiuso a mano

Juego de válvula semiautomática y rebosadero de cierre manual



84 700 000

Cutting board

Tagliere

Tabla de cortar

^h Pop-up waste and overflow sets are only compatible with single sinks in Polished Stainless Steel. / Le pilette e troppopieno sono compatibili solo con i singoli lavelli in acciaio inox lucido. / Los juegos de desagüe y rebosadero solo son compatibles con fregaderos individuales en acero inox pulido.

ⁱ This item is only compatible with item 38 180 003. / Questo articolo è compatibile soltanto con il 38 180 003. / Este artículo solo es compatible con el 38 180 003.





TARA



ULTRA

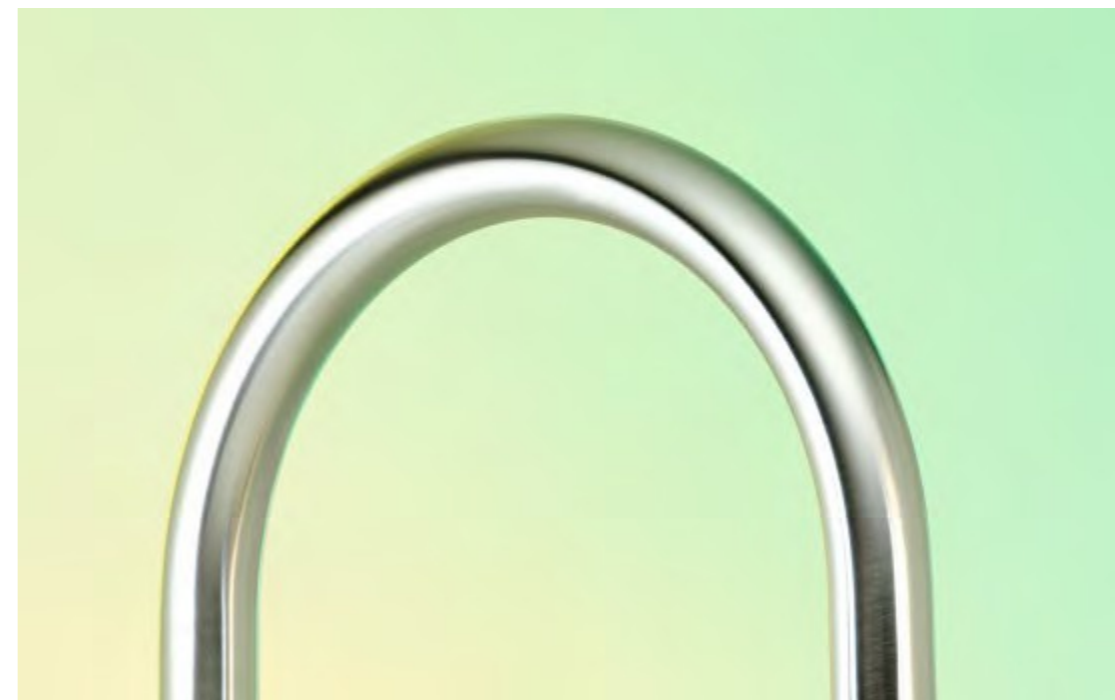



EN Versatile and function-based – that's TARA ULTRA. With the high spout and ergonomically placed handle, it covers a wide range of applications: from the single-lever mixer with or without the spray on the side to the PULL DOWN and Profi fitting.

IT Versatile e orientata alle funzioni: questa è TARA ULTRA. Con la sua bocca alta e l'impugnatura posizionata ergonomicamente, copre una vasta gamma di applicazioni: dai miscelatori monocomando con o senza doccia sul piano, dai miscelatori PULL-DOWN e ai miscelatori professionali.

ES Versátil y funcional: así es TARA ULTRA. Con su elevado caño de salida y su maneta colocada ergonómicamente, abarca los diferentes campos de aplicación: desde el mezclador monomando con o sin juego de ducha lateral, la grifería PULL-DOWN y hasta la grifería Profi.



The Functional



TARA ULTRA BRUSHED PLATINUM

functional
modern
specific

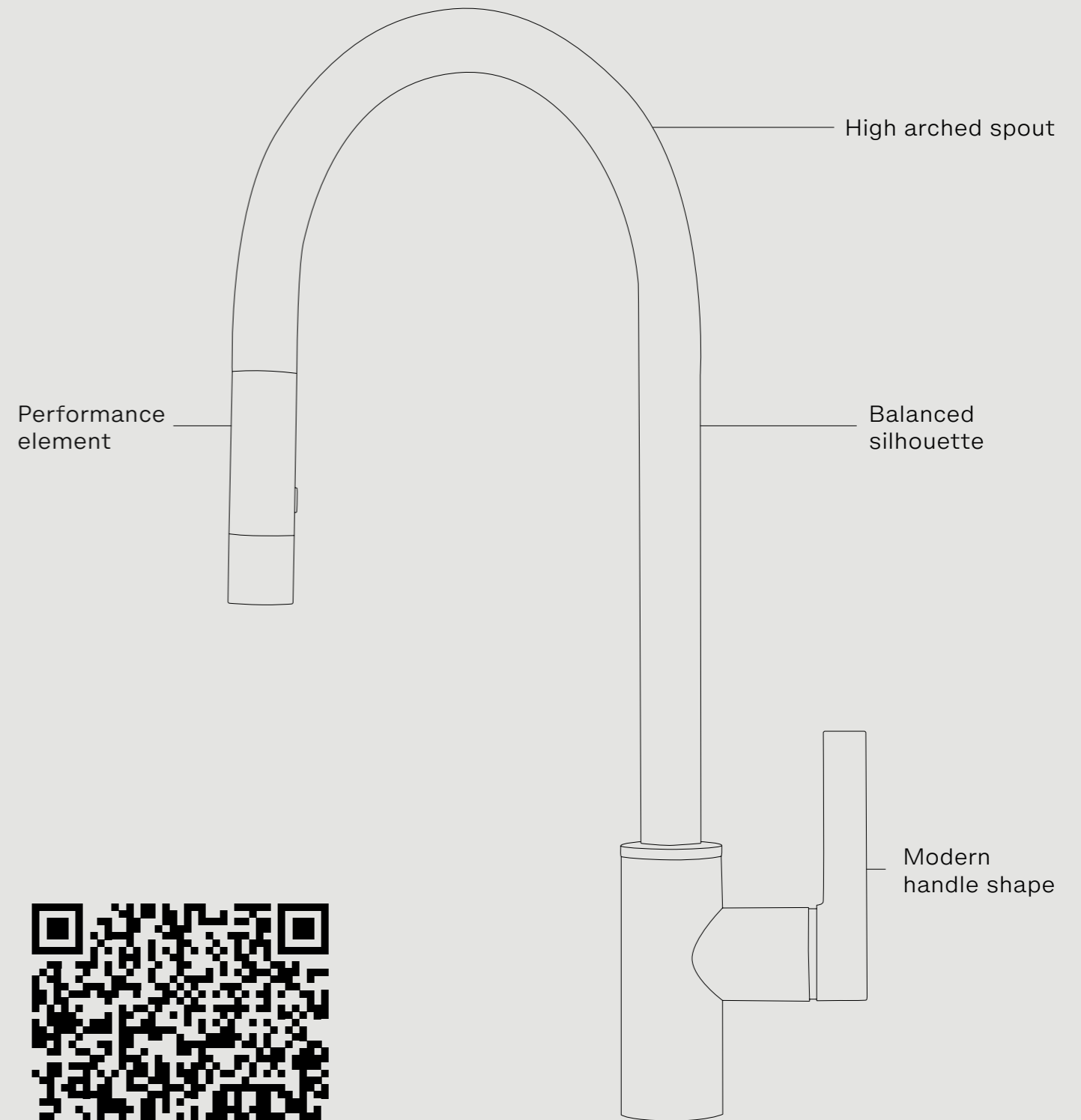



Sophisticated Steel

EN Harmonious interplay for modern, function-based kitchens: TARA ULTRA meets gentle hues with matte surfaces and materials.

HCWD not available in Germany

IT Interazione armoniosa per cucine moderne e funzionali, TARA ULTRA incontra superfici e materiali dai toni morbidi ed opachi.

HCWD non disponibile in Germania

ES Un conjunto armonioso para cocinas modernas y funcionales: TARA ULTRA se fusiona con suaves tonalidades y acabados y materiales mate.

HCWD no disponible en Alemania



EN The high extending spout provides the space with flexibility.

IT La bocca alta ed estensibile offre flessibilità di movimento.

ES El alto caño extraíble ofrece libertad para un manejo flexible.

EN Professional in use: with the practical POT FILLER, the PULL-DOWN fitting and the Profi fitting, TARA ULTRA covers an extremely wide range of applications.

IT TARA ULTRA copre una vasta gamma di applicazioni con la pratica versione POT FILLER, il miscelatore PULL-DOWN ed il miscelatore professionale.

ES Uso profesional: con el práctico POT FILLER, la grifería PULL-DOWN o la grifería Profi, TARA ULTRA abarca los campos de aplicación más diversos.



For Professionals



limed douglas fir
stainless steel
travertine & silk
bronze-tinted glass

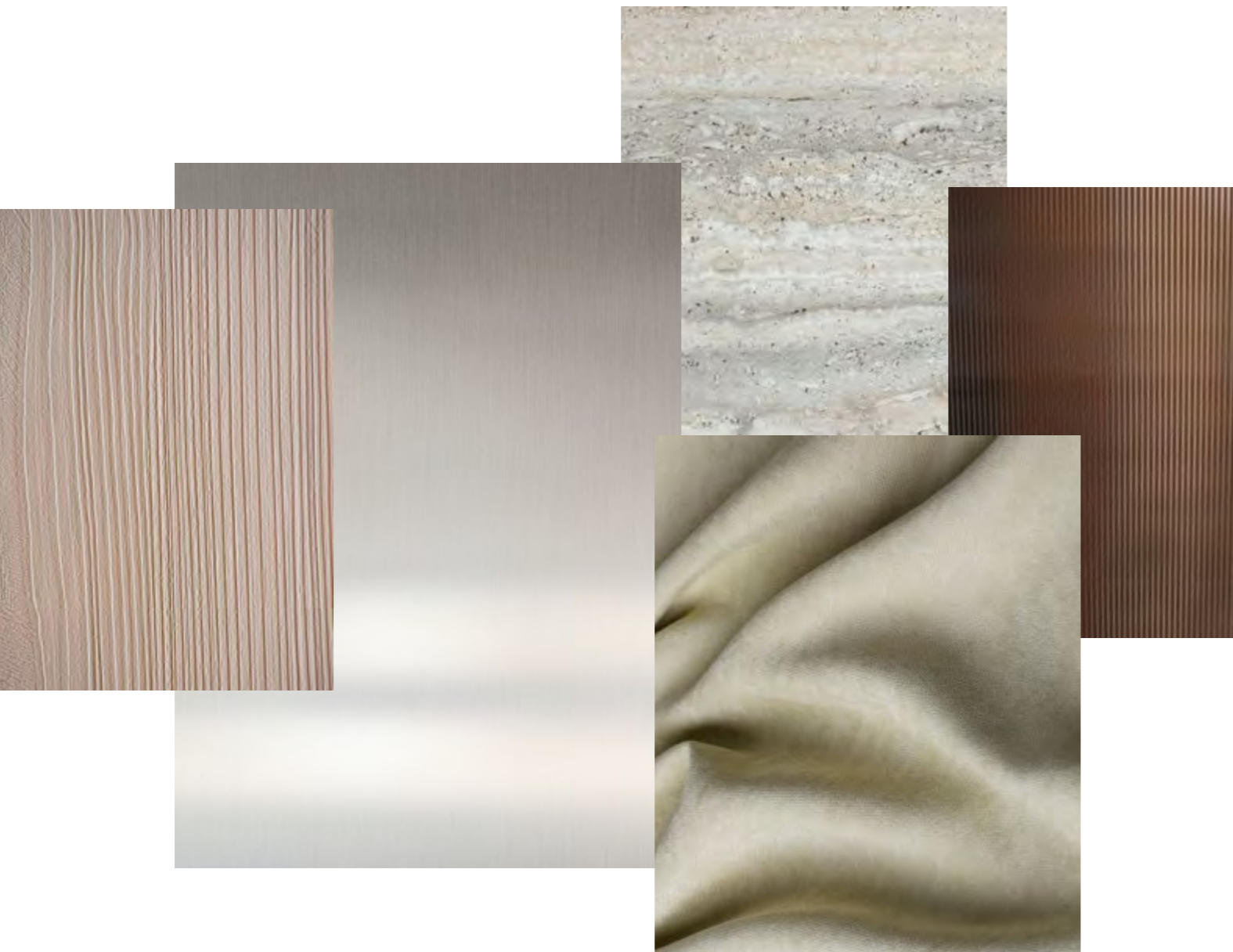

Materials





TARA ULTRA Selected Products

EN TARA ULTRA offers professional kitchen fittings for the private area: as well as the special product range, a selection of individual finishes is also available – from Chrome and Dark Chrome to Champagne (22kt Gold).

IT TARA ULTRA offre rubinetti da cucina professionali nel settore privato: oltre alla gamma prodotti, è disponibile una selezione di finiture: dal Cromato al Dark Chrome, allo Champagne (Oro 22 ct).

ES TARA ULTRA ofrece griferías de cocina profesionales para el ámbito privado: junto a la especial variedad de la gama, se ofrece una selección de acabados individuales: desde Cromo y Dark Chrome, hasta Champagne (Oro 22k).

Product Information
 Informazioni sui prodotti
 Información de producto

^{EN} Excerpt from the product range.
 More detailed information can be obtained from your dealer. Due to the printing technique used here, the colours shown may vary from the true colour of the actual finish.

^{IT} Estratto dalla gamma completa prodotti.
 Il Vostro rivenditore specializzato sarà lieto di fornirvi maggiori informazioni. Per motivi tecnici di stampa non possiamo garantire la fedeltà dei colori qui riprodotti.

^{ES} Extracto del programa de productos.
 Si desea más información consulte con su comercio habitual. Los acabados reproducidos en el presente catálogo no son vinculantes por razones de impresión.

Finishes for fittings
 Finiture rubinetteria
 Acabados grifería



00
 Chrome
 Cromato
 Cromo

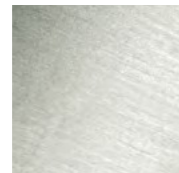

93
 Brushed Chrome
 Cromo spazzolato
 Cromo cepillado



08
 Platinum
 Platinato
 Platino

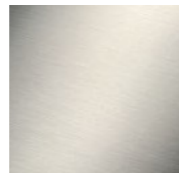

06
 Brushed Platinum
 Platinato spazzolato
 Platino cepillado

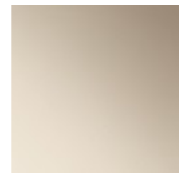

47
 Champagne (22kt Gold)
 Champagne (Oro 22k)
 Champagne (Oro 22k)

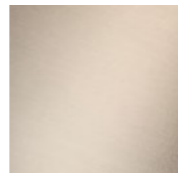

46
 Brushed Champagne
 (22kt Gold)
 Champagne spazzolato
 (Oro 22k)
 Champagne cepillado
 (Oro 22k)

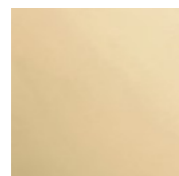

09
 Durabress (23kt Gold)
 Ottone (Oro 23k)
 Latón (Oro 23k)

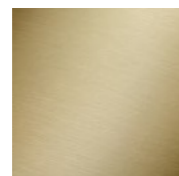

28
 Brushed Durabress
 (23kt Gold)
 Ottone spazzolato
 (Oro 23k)
 Latón cepillado (Oro 23k)



19
 Dark Chrome
 Dark Chrome
 Dark Chrome

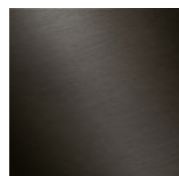

99
 Brushed Dark Platinum
 Dark Platinum spazzolato
 Dark Platinum cepillado



33
 Matte Black
 Nero opaco
 Negro mate

Fittings
 Rubinetti
 Griferías



33 870 875
 Single-lever mixer Pull-down with spray function
 Miscelatore monocomando ad estrazione Pull-down con funzione doccia
 Monomando Pull-down con función de chorro
 [max. 10,4 l/min.]



33 816 875
 Single-lever mixer
 Miscelatore monocomando
 Monomando
 [max. 7 l/min.]



33 860 875 ^a
 Profi single-lever mixer
 Miscelatore monocomando professionale
 Monomando Profi
 [max. 8 l/min.]



33 826 875 + 27 721 970
 Single-lever mixer with side spray set
 Miscelatore monocomando con gruppo doccia lavello
 Monomando con rociador de cocina
 [max. 8 l/min.]



17 861 875 ^b
 HOT & COLD WATER DISPENSER
 HOT & COLD WATER DISPENSER
 HOT & COLD WATER DISPENSER
 [max. 2 l/min.]



33 826 875 + 27 789 970 ^a
 Single-lever mixer with Profi spray set
 Miscelatore monocomando con gruppo doccia professionale
 Monomando con rociador de cocina profesional
 [max. 8 l/min.]



33 805 875
 BAR TAP Single-lever mixer
 BAR TAP Miscelatore monocomando
 BAR TAP Monomando
 [max. 8 l/min.]



32 815 875
 Two-hole mixer with individual rosettes
 Miscelatore monocomando a due fori con rosette separate
 Batería monomando de dos orificios con rosetas individuales
 [max. 8 l/min.]



33 800 875
 Single-lever mixer
 Miscelatore monocomando
 Monomando
 [max. 8 l/min.]



32 815 875 + 27 731 970
 Two-hole mixer with individual flanges with side spray set
 Miscelatore monocomando a due fori con rosette separate con gruppo doccia lavello
 Batería monomando de dos orificios con rosetas individuales con rociador de cocina
 [max. 8 l/min.]

^a Item not available in finishes 47, 46, 09, 28 and 33. / Articolo non disponibile nelle superfici 47, 46, 09, 28 e 33. / Artículo no disponible en los acabados 47, 46, 09, 28 y 33.

^b You need the corresponding system components for this product. This product is not available in Germany. / Per questo prodotto, sono necessari componenti di sistema appropriati. Questo prodotto non è disponibile in Germania. / Para este producto necesita los componentes de sistema adecuados. Este producto no puede solicitarse en Alemania.

Fittings Rubinetti Griferías



32 815 875 + 27 799 970^c
Two-hole mixer with individual flanges with Profi spray set
Miscelatore monocomando a due fori con rosette separate con gruppo doccia professionale
Batería monomando de dos orificios con rosetas individuales con rociador de cocina profesional
[max. 8 l/min.]



30 805 875^e
POT FILLER Cold-water valve
POT FILLER rubinetto acqua fredda con bocca girevole
POT FILLER Válvula de agua fría
[max. 5,7 l/min.]



33 845 875^d
PIVOT Single-lever mixer
PIVOT Miscelatore monocomando
PIVOT Monomando
[max. 8 l/min.]

Accessories Accessori Complementos



82 424 970
Dispenser without rosette
Dispenser senza rosetta
Dispenser sin rosetta



12 715 970
Cover for tap hole
Copertura per foro di montaggio
Tapón de orificio



10 713 970
AIR SWITCH Control button
AIR SWITCH pulsante di comando
AIR SWITCH botón de manejo



83 251 220
Hooks
Gancio
Gancho



10 712 970
Strainer waste with control handle
Comando piletta ad eccentrico con manopola
Accionamiento excéntrico manual con maneta de control giratoria



83 060 979^f
Towel bar
Asta portasciugamani
Barra colgador



83 080 979^f
Towel bar
Asta portasciugamani
Barra colgador

Sinks and accessories Lavelli e accessori da cucina Fregaderos y complementos

Universal

DESIGN COLLECTIONS TARA ULTRA

Serie neutra

Genérico



Single sink in polished stainless steel, available in the following dimensions:

Lavello singolo in acciaio inox lucido. Disponibile nelle seguenti misure:

Fregadero individual de acero inox pulido, disponible en las siguientes medidas:

18 x 40 cm: 38 180 003
34 x 40 cm: 38 340 003
40 x 40 cm: 38 400 003
45 x 40 cm: 38 450 003
50 x 40 cm: 38 500 003
55 x 40 cm: 38 550 003
65 x 40 cm: 38 650 003

85
Polished Stainless Steel
Acciaio inox lucido
Acero inox pulido



10 400 003^g
Pop-up waste and overflow closable by hand
Sistema piletta con troppo pieno può essere chiuso a mano
Juego de válvula semiautomática y rebosadero de cierre manual



10 410 003^g
Pop-up waste and overflow with electronic control
Sistema piletta con troppo pieno con controllo elettronico
Juego de válvula semiautomática y rebosadero electrónico



10 405 003^g
Pop-up waste and overflow with knob
Sistema piletta con troppo pieno con pomello
Juego de válvula semiautomática y rebosadero con tirador



10 415 003^{g, h}
Pop-up waste and overflow closable by hand
Sistema piletta con troppo pieno può essere chiuso a mano
Juego de válvula semiautomática y rebosadero de cierre manual



84 700 000
Cutting board
Tagliere
Tabla de cortar

^c Item not available in finishes 47, 46, 09, 28 and 33. / Articolo non disponibile nelle superfici 47, 46, 09, 28 e 33. / Artículo no disponible en los acabados 47, 46, 09, 28 y 33.

^d Item not available in finish 33. / Articolo non disponibile nella superficie 33. / Artículo no disponible en el acabado 33.

^e A rough parts kit is required for this article. Item not available in finish 33. / Per questo articolo è necessario un kit di parti ad incasso.

Articolo non disponibile nella superficie 33. / Se requiere un kit de partes empotradas para este artículo. Artículo no disponible en el acabado 33.

^f Item not available in finishes 08, 09 and 99. / Articolo non disponibile nelle superfici 08, 09 e 99. / Artículo no disponible en los acabados 08, 09 y 99.

^g Pop-up waste and overflow sets are only compatible with single sinks in Polished Stainless Steel. / Le pilette e troppopieno sono compatibili solo con i singoli lavelli in acciaio inox lucido. / Los juegos de desagüe y rebosadero solo son compatibles con fregaderos individuales en acero inox pulido.

^h This item is only compatible with item 38 180 003. / Questo articolo è compatibile soltanto con il 38 180 003. / Este artículo solo es compatible con el 38 180 003.



LOT

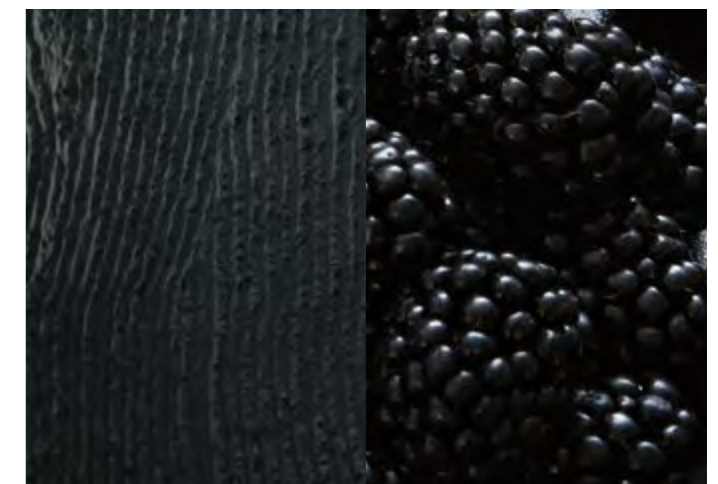

The Architectural

EN LOT embodies architectural precision. Minimalist, but expressive. Its simple and sculptural form makes a statement in the kitchen.

IT LOT incarna la precisione architettonica. Minimalista, ma espressivo. La sua forma scultorea è una nota sorprendente in cucina.

ES LOT irradia precisión arquitectónica. Minimalista, pero expresiva. Su forma reducida y escultural constituye toda una declaración en la cocina.



LOT BRUSHED DARK PLATINUM

architectural
sophisticated
precise

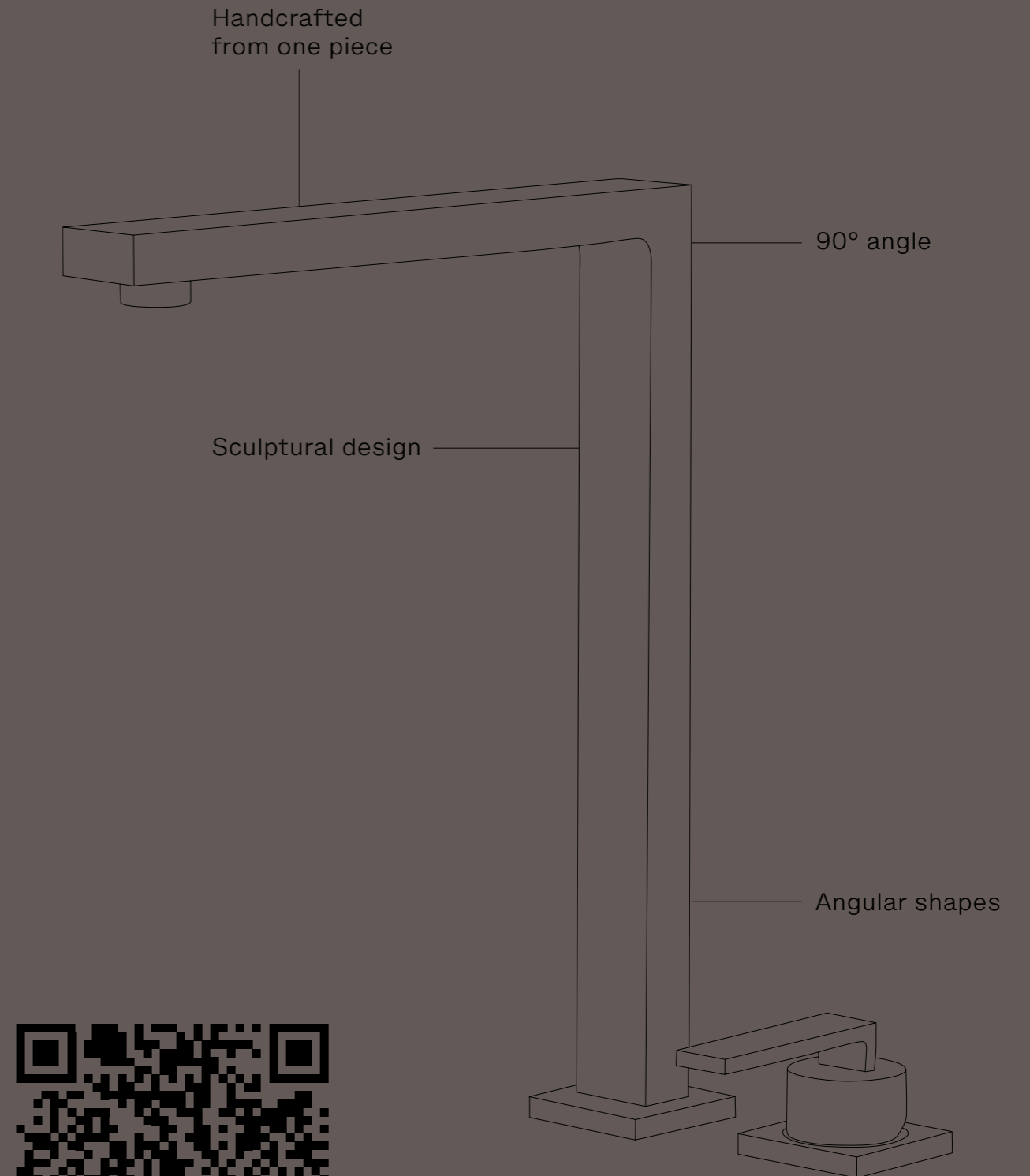

Find out more about LOT at dornbracht.com/lot



Layers of Black

^{EN} A wide variety of shades and textures in black create a minimalist, avant-garde setting where LOT finds its place as a sculptural highlight.

^{IT} Un'ampia varietà di sfumature e texture nere creano un ambiente minimalista-avanguardista in cui LOT, nella sua forma lineare, risalta e arricchisce l'ambiente.

^{ES} Las tonalidades y las texturas más diversas en negro crean un entorno minimalista y vanguardista, en el que LOT encuentra su espacio como elemento estrella escultural.



^{EN} Aesthetic meets functional features for precision working: LOT combined with the practical rinsing spray set.

^{IT} L'estetica incontra le caratteristiche funzionali: LOT abbinato al pratico gruppo doccetta da piano.

^{ES} Estética y funcionalidad en pro de un uso más preciso: LOT combinado con el práctico juego de grifo de cocina.

A Statement of Style



EN For kitchens with personality: the Platinum finish underlines the style-defining design of LOT and adds expressive accents.

IT Per cucine con personalità: la finitura platinato lucido sottolinea il design che definisce lo stile di LOT e crea espressività e contrasto.

ES Para cocinas con personalidad: el acabado Platino subraya el diseño que marca estilo de LOT y pone toques expresivos.



solid stone
black stained oak
black granite
mirrored glass

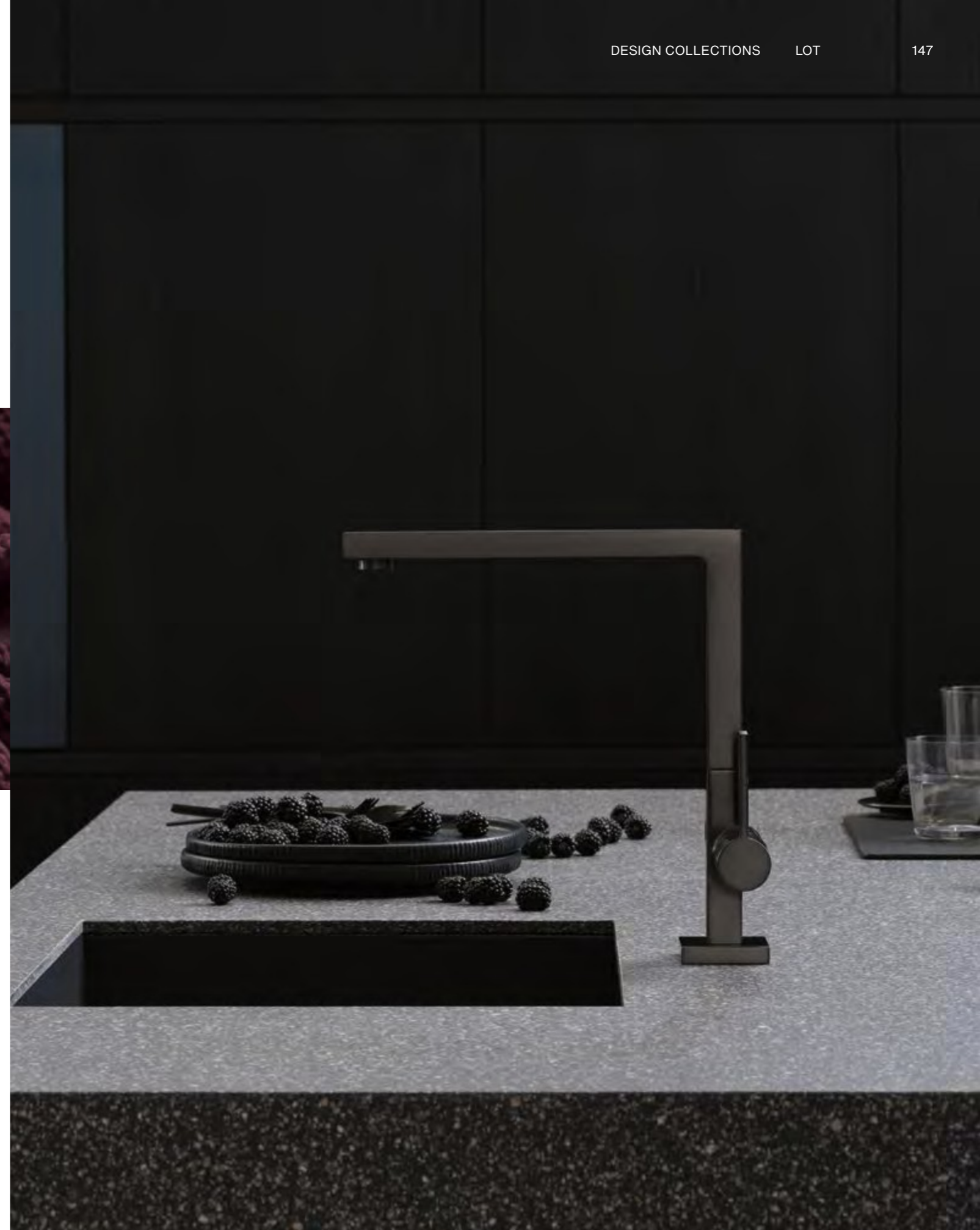
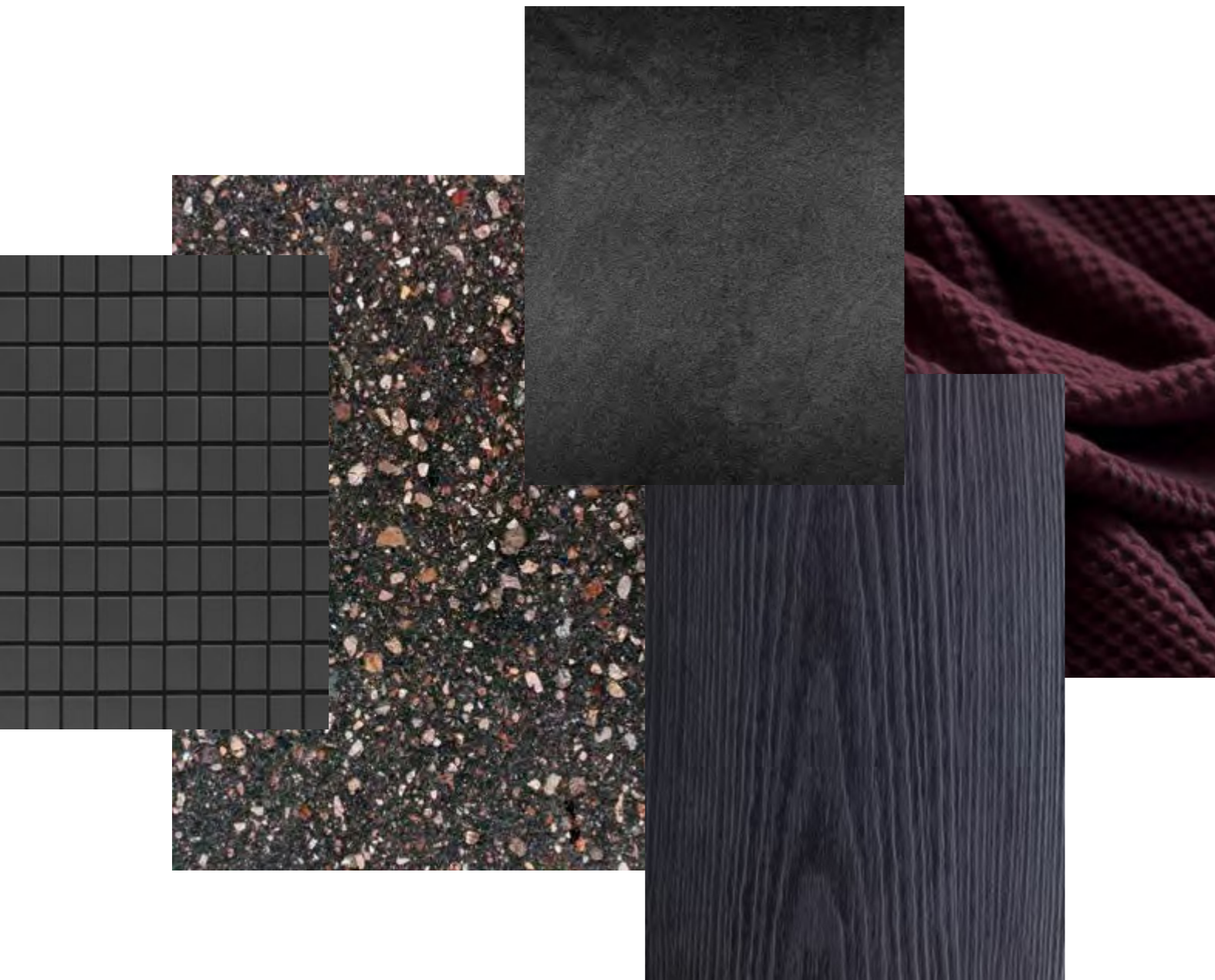

Materials



^{EN} Whether Brushed Platinum or Brushed Dark Platinum: LOT accentuates its setting not only with its sculptural form, but also with the range of finishes that are perfect for integrating in avant-garde style worlds.

^{IT} Platinato spazzolato o Dark Platinum spazzolato: LOT accentua l'ambiente circostante non solo attraverso la sua forma scultorea, ma anche attraverso la varietà di finiture che si possono integrare in mondi di stile d'avanguardia.

^{ES} Platino cepillado o Dark Platinum cepillado: LOT acentúa su entorno, no solo con su forma escultural, sino también con su gran variedad de acabados, que también puede integrarse en estilos vanguardistas.

LOT Selected Products

Product Information
 Informazioni sui prodotti
 Información de producto

^{EN} Excerpt from the product range.
 More detailed information can be obtained from your dealer. Due to the printing technique used here, the colours shown may vary from the true colour of the actual finish.

^{IT} Estratto dalla gamma completa prodotti.
 Il Vostro rivenditore specializzato sarà lieto di fornirvi maggiori informazioni. Per motivi tecnici di stampa non possiamo garantire la fedeltà dei colori qui riprodotti.

^{ES} Extracto del programa de productos.
 Si desea más información consulte con su comercio habitual. Los acabados reproducidos en el presente catálogo no son vinculantes por razones de impresión.

Finishes for fittings
 Finiture rubinetteria
 Acabados grifería



00
 Chrome
 Cromato
 Cromo



08
 Platinum
 Platinato
 Platino

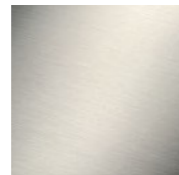

06
 Brushed Platinum
 Platinato spazzolato
 Platino cepillado

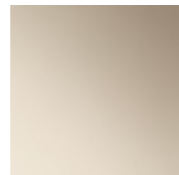

47
 Champagne (22kt Gold)
 Champagne (Oro 22k)
 Champagne (Oro 22k)

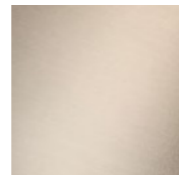

46
 Brushed Champagne
 (22kt Gold)
 Champagne spazzolato
 (Oro 22k)
 Champagne cepillado
 (Oro 22k)

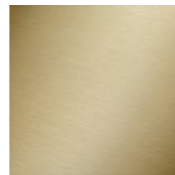

28
 Brushed Durabronze
 (23kt Gold)
 Ottone spazzolato (Oro 23k)
 Latón cepillado (Oro 23k)



19
 Dark Chrome
 Dark Chrome
 Dark Chrome

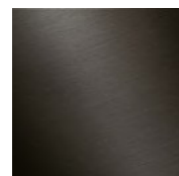

99
 Brushed Dark Platinum
 Dark Platinum spazzolato
 Dark Platinum cepillado

Fittings
 Rubinetti
 Griferías

DESIGN COLLECTIONS LOT



17 861 680 ^a
 HOT & COLD WATER DISPENSER
 HOT & COLD WATER DISPENSER
 HOT & COLD WATER DISPENSER
 [max. 2 l/min.]



32 800 680
 Two-hole mixer
 with individual rosettes
 Miscelatore monocomando a due fori con rosette separate
 Batería monomando de dos orificios con rosetas individuales
 [max. 8 l/min.]



32 805 680
 BAR TAP Two-hole mixer
 with individual rosettes
 BAR TAP Miscelatore monocomando a due fori con rosette separate
 BAR TAP Batería monomando de dos orificios con rosetas individuales
 [max. 8 l/min.]



32 800 680 + 27 722 970
 Two-hole mixer with individual flanges with side spray set
 Miscelatore monocomando a due fori con rosette separate con gruppo doccetta lavello
 Batería monomando de dos orificios con rosetas individuales con rociador de cocina
 [max. 8 l/min.]



33 800 680
 Single-lever mixer
 Miscelatore monocomando
 Monomando
 [max. 8 l/min.]



32 800 680 + 27 784 970 ^b
 Two-hole mixer with individual flanges with Profi spray set
 Miscelatore monocomando a due fori con rosette separate con gruppo doccetta professionale
 Batería monomando de dos orificios con rosetas individuales con rociador de cocina profesional
 [max. 8 l/min.]



33 826 680 + 27 723 970
 Single-lever mixer with side spray set
 Miscelatore monocomando con gruppo doccetta lavello
 Monomando con rociador de cocina
 [max. 8 l/min.]



32 843 680
 Two-hole mixer with cover plate
 Miscelatore monocomando a due fori con piastra di copertura
 Batería monomando de dos orificios con cubierta
 [max. 8 l/min.]



33 826 680 + 27 785 970 ^b
 Single-lever mixer with Profi spray set
 Miscelatore monocomando con gruppo doccetta professionale
 Monomando con rociador de cocina profesional
 [max. 8 l/min.]



32 843 680 + 27 722 970
 Two-hole mixer with cover plate with side spray set
 Miscelatore monocomando a due fori con piastra di copertura con gruppo doccetta lavello
 Batería monomando de dos orificios con cubierta con rociador de cocina
 [max. 8 l/min.]

^a You need the corresponding system components for this product. This product is not available in Germany. / Per questo prodotto, sono necessari componenti di sistema appropriati. Questo prodotto non è disponibile in Germania. / Para este producto necesita los componentes de sistema adecuados. Este producto no puede solicitarse en Alemania.

^b Item not available in finishes 47, 46 and 28. / Articolo non disponibile nelle superfici 47, 46 e 28. / Artículo no disponible en los acabados 47, 46 y 28.

Fittings
Rubinetti
Griferías



32 843 680 + 27 784 970 ^c
Two-hole mixer with cover plate with Profi spray set
Miscelatore monocomando a due fori con piastra di copertura con gruppo doccetta professionale
Batería monomando de dos orificios con cubierta con rociador de cocina profesional
[max. 8 l/min.]

Accessories
Accessori
Complementos



12 715 970
Cover for tap hole
Copertura per foro di montaggio
Tapón de orificio



10 714 970 ^d
AIR SWITCH Control button
AIR SWITCH pulsante di comando
AIR SWITCH botón de manejo



10 711 970 ^d
Strainer waste with control handle
Comando piletta ad eccentrico con manopola con manopola
Accionamiento excéntrico manual con maneta de control giratoria



82 439 970 ^d
Dispenser with rosette
Dispenser con rosetta
Dispensador con roseta



83 251 780 ^e
Hooks
Gancio
Gancho

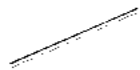

83 045 670 ^f
Towel bar
Asta portasciugamani
Barra colgador

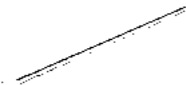

83 060 670 ^f
Towel bar
Asta portasciugamani
Barra colgador

Sinks and accessories Universal

Lavelli e accessori da cucina Serie neutra
Fregaderos y complementos Genérico



Single sink in polished stainless steel, available in the following dimensions:
Lavello singolo in acciaio inox lucido, Disponibile nelle seguenti misure:
Fregadero individual de acero inox pulido, disponible en las siguientes medidas:
18 x 40 cm: 38 180 003
34 x 40 cm: 38 340 003
40 x 40 cm: 38 400 003
45 x 40 cm: 38 450 003
50 x 40 cm: 38 500 003
55 x 40 cm: 38 550 003
65 x 40 cm: 38 650 003

85
Polished Stainless Steel
Acciaio inox lucido
Acero inox pulido



10 400 003 ^g
Pop-up waste and overflow closable by hand
Sistema piletta con troppo pieno può essere chiuso a mano
Juego de válvula semiautomática y rebosadero de cierre manual



10 405 003 ^g
Pop-up waste and overflow with knob
Sistema piletta con troppo pieno con pomello
Juego de válvula semiautomática y rebosadero con tirador



10 410 003 ^g
Pop-up waste and overflow with electronic control
Sistema piletta con troppo pieno con controllo elettronico
Juego de válvula semiautomática y rebosadero electrónico



10 415 003 ^{g, h}
Pop-up waste and overflow closable by hand
Sistema piletta con troppo pieno può essere chiuso a mano
Juego de válvula semiautomática y rebosadero de cierre manual



84 700 000
Cutting board
Tagliere
Tabla de cortar

^c Item not available in finishes 47, 46 and 28. / Articolo non disponibile nelle superfici 47, 46 e 28. / Artículo no disponible en los acabados 47, 46 y 28.
^d Item not available in finish 33. / Articolo non disponibile nella superficie 33. / Artículo no disponible en el acabado 33.
^e Item not available in finishes 93, 09 and 33. / Articolo non disponibile nelle superfici 93, 09 e 33. / Artículo no disponible en los acabados 93, 09 y 33.

^f Item not available in finishes 08, 09, 28, 46, 47, 19, 99 and 33. / Articolo non disponibile nelle superfici 08, 09, 28, 46, 47, 19, 99 e 33. / Artículo no disponible en los acabados 08, 09, 28, 46, 47, 19, 99 y 33.
^g Pop-up waste and overflow sets are only compatible with single sinks in Polished Stainless Steel. / Le pilette e troppopieno sono compatibili solo con i singoli lavelli in acciaio inox lucido. / Los juegos de desagüe y rebosadero solo son compatibles con fregaderos individuales en acero inox pulido.
^h This item is only compatible with item 38 180 003. / Questo articolo è compatibile soltanto con il 38 180 003. / Este artículo solo es compatible con el 38 180 003.



SYNC

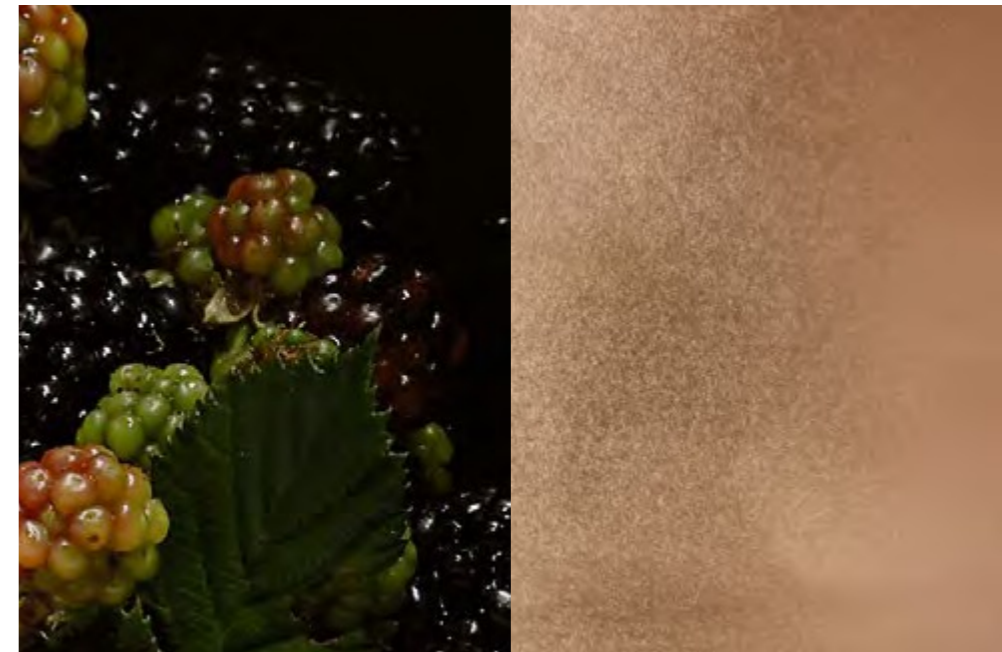

EN SYNC combines progressive design with first-class performance. Thanks to the extending spout, the PULL-DOWN single-lever mixer increases the radius of movement in the kitchen.

IT SYNC combina un design iconico con elevate prestazioni. Grazie alla sua bocca estraibile, il miscelatore monocomando PULL-DOWN aumenta il raggio di movimento in cucina.

ES SYNC fusiona diseño progresivo con un rendimiento de primera. Gracias a su caño extraíble, el mezclador monomando PULL-DOWN aumenta el radio de movimiento en la cocina.

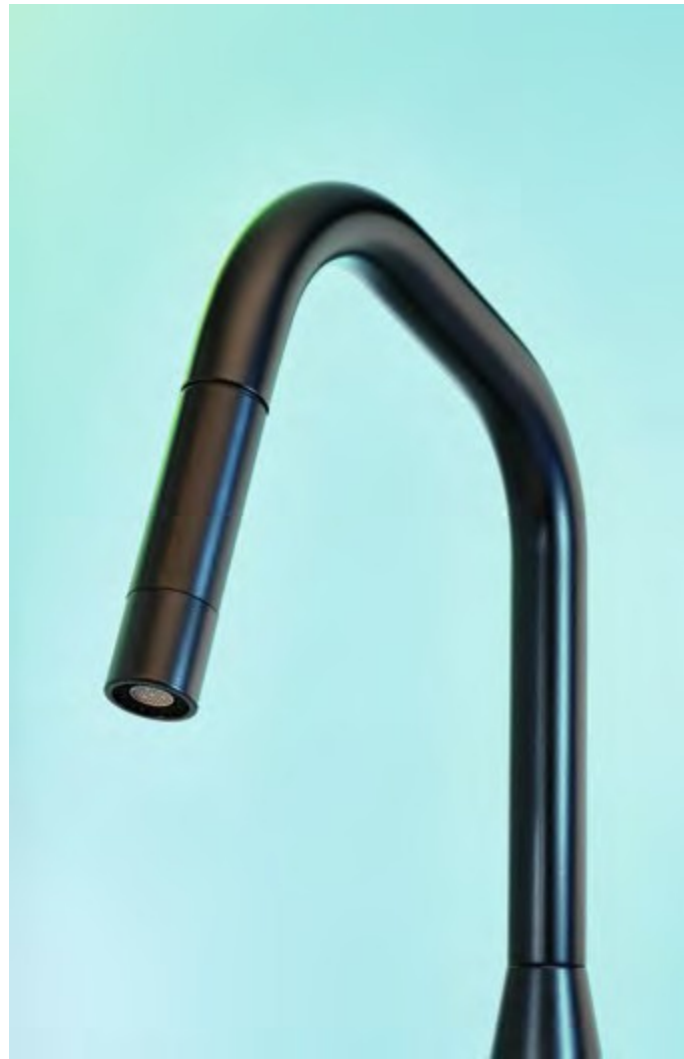

The Progressive



SYNC BLACK MATTE

progressive
dynamic
performing

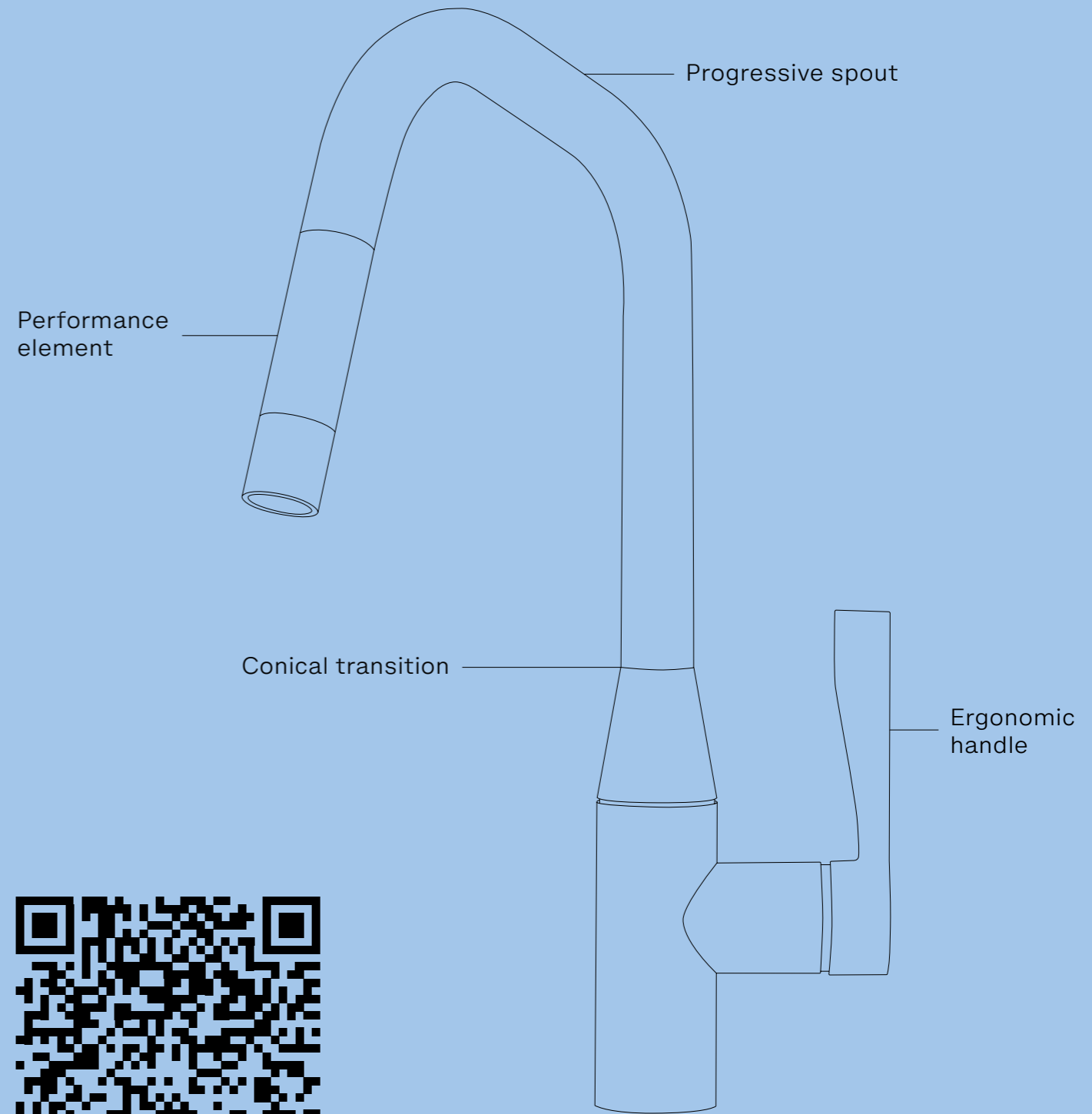

Find out more about SYNC at dornbracht.com/sync



Progressive Variety

^{EN} A dynamic design for a professional kitchen in your own home – courtesy of SYNC. A progressive mix of various materials creates a unique look.

^{IT} SYNC offre un design dinamico per la cucina professionale a casa vostra. Un mix di materiali diversi crea un look invidiabile.

^{ES} Un diseño dinámico para la cocina profesional en su propia casa: esto es lo que le ofrece SYNC. Una mezcla progresiva de diversos materiales crea un look nunca visto.



^{EN} Practical with everyday actions: the SYNC Profi fitting has a flexible silicone hose that makes washing vegetables or dishes much easier.

^{IT} Pratico per le attività quotidiane: il rubinetto professionale SYNC facilita il lavaggio con il tubo flessibile in silicone.

^{ES} Práctico en los movimientos cotidianos: la grifería Profi SYNC facilita, con su manguera de silicona flexible, el lavado de verduras o vajilla.

Cooking Enthusiasm



EN Precise and point-specific: the PULL-DOWN single-lever mixer with spray function swivels in a 360° radius, and switches from laminar to spray flow as required.

IT Preciso e azzeccato: il miscelatore monocomando PULL-DOWN con funzione doccia si può ruotare in un raggio di 360° e può passare dal getto laminare al getto doccia a seconda delle esigenze.

ES Gran precisión: el mezclador monomando PULL-DOWN con función de ducha rociadora puede girarse en un radio de 360° y, según las necesidades, puede variar de chorro laminar a chorro de ducha.

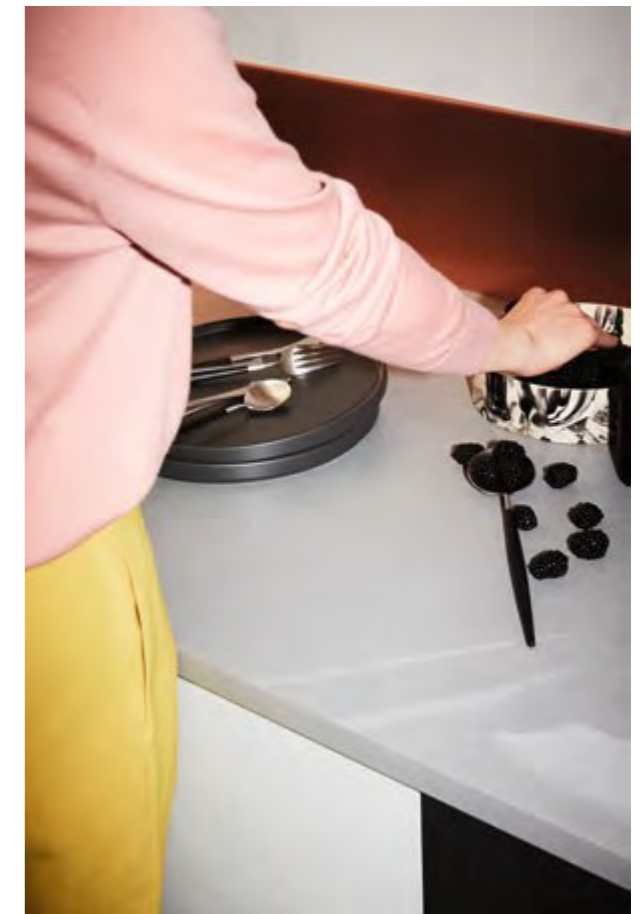

sustainable fabric
copper & terrazzo
bianco carrara marble
slate stone

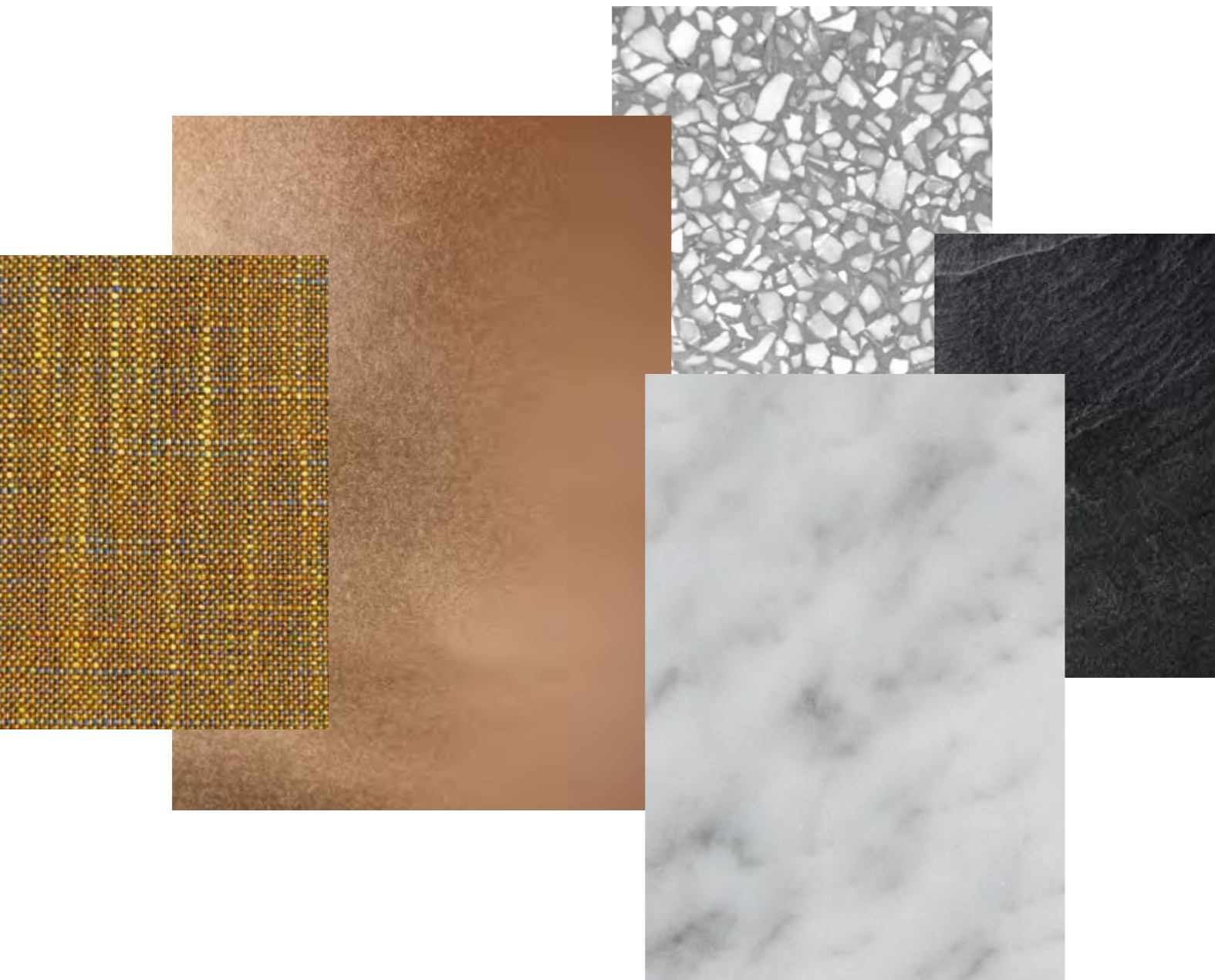

Materials



EN With its dynamic character, SYNC fits beautifully in progressive kitchen worlds and offers a wide range of applications for your kitchen, from the PULL-DOWN fitting with spray function to the Profi fitting – all with the matching detergent dispensers.

IT Grazie al suo carattere dinamico, SYNC si inserisce nel mondo della cucina all'avanguardia e offre una vasta gamma di applicazioni, dai rubinetti PULL-DOWN con funzione doccia ai rubinetti professionali, incluso un dispenser abbinato.

ES Con su carácter dinámico, SYNC se integra en mundos de cocina progresivos y ofrece, desde la grifería PULL-DOWN con función de ducha rociadora hasta la grifería Profi, las más diversas aplicaciones para su cocina: incluyendo un dispensador de detergente apropiado.



SYNC Selected Products

Product Information
 Informazioni sui prodotti
 Información de producto

^{EN} Excerpt from the product range.
 More detailed information can be obtained from your dealer. Due to the printing technique used here, the colours shown may vary from the true colour of the actual finish.

^{IT} Estratto dalla gamma completa prodotti.
 Il Vostro rivenditore specializzato sarà lieto di fornirvi maggiori informazioni. Per motivi tecnici di stampa non possiamo garantire la fedeltà dei colori qui riprodotti.

^{ES} Extracto del programa de productos.
 Si desea más información consulte con su comercio habitual. Los acabados reproducidos en el presente catálogo no son vinculantes por razones de impresión.

Finishes for fittings
 Finiture rubinetteria
 Acabados grifería



00
 Chrome
 Cromato
 Cromo



93
 Brushed Chrome
 Cromo spazzolato
 Cromo cepillado



08
 Platinum
 Platinato
 Platino

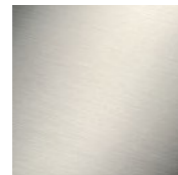

06
 Brushed Platinum
 Platinato spazzolato
 Platino cepillado



47
 Champagne (22kt Gold)
 Champagne (Oro 22k)
 Champagne (Oro 22k)

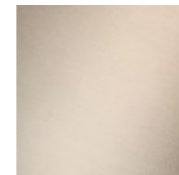

46
 Brushed Champagne
 (22kt Gold)
 Champagne spazzolato
 (Oro 22k)
 Champagne cepillado
 (Oro 22k)

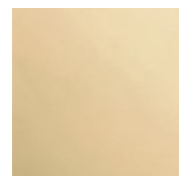

09
 Durabrace (23kt Gold)
 Ottone (Oro 23k)
 Latón (Oro 23k)

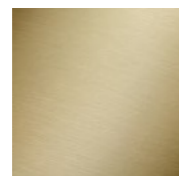

28
 Brushed Durabrace
 (23kt Gold)
 Ottone spazzolato
 (Oro 23k)
 Latón cepillado (Oro 23k)



19
 Dark Chrome
 Dark Chrome
 Dark Chrome

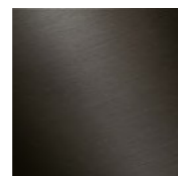

99
 Brushed Dark Platinum
 Dark Platinum spazzolato
 Dark Platinum cepillado



33
 Matte Black
 Nero opaco
 Negro mate

Fittings
 Rubinetti
 Griferías



33 875 895
 Single-lever mixer Pull-down with spray function
 Miscelatore monocomando ad estrazione Pull-down con funzione doccia
 Monomando Pull-down con función de chorro
 [max. 10,4 l/min.]



33 870 895
 Single-lever mixer Pull-down with spray function
 Miscelatore monocomando ad estrazione Pull-down con funzione doccia
 Monomando Pull-down con función de chorro
 [max. 10,4 l/min.]



33 865 895
 Profi single-lever mixer
 Miscelatore monocomando professionale
 Monomando Profi
 [max. 9,5 l/min.]



30 805 875 ^a
 POT FILLER Cold-water valve
 POT FILLER rubinetto acqua fredda con bocca girevole
 POT FILLER Válvula de agua fría
 [max. 5,7 l/min.]

^a A rough parts kit is required for this article. Item not available in finish 33. / Per questo articolo è necessario un kit di parti ad incasso. Articolo non disponibile nella superficie 33. / Se requiere un kit de partes empotradas para este artículo. Artículo no disponible en el acabado 33.

Accessories
 Accessori
 Complementos

Sinks and accessories Universal
 Lavelli e accessori da cucina Serie neutra
 Fregaderos y complementos Genérico



82 424 970
 Dispenser without rosette
 Dispenser senza rosetta
 Dispensador sin roseta



83 060 979 ^b
 Towel bar
 Asta portasciugamani
 Barra colgador



10 713 970
 AIR SWITCH Control button
 AIR SWITCH pulsante di comando
 AIR SWITCH botón de manejo



83 080 979 ^b
 Towel bar
 Asta portasciugamani
 Barra colgador



10 712 970
 Strainer waste with control handle
 Comando piletta ad eccentrico con manopola con manopola
 Accionamiento excéntrico manual con maneta de control giratoria



12 715 970
 Cover for tap hole
 Copertura per foro di montaggio
 Tapón de orificio



83 251 220
 Hooks
 Gancio
 Gancho



34 x 40 cm

85
 Polished Stainless Steel
 Acciaio inox lucido
 Acero inox pulido

Single sink in polished stainless steel, available in the following dimensions:

Lavello singolo in acciaio inox lucido, Disponibile nelle seguenti misure:

Fregadero individual de acero inox pulido, disponible en las siguientes medidas:

- 18 x 40 cm: 38 180 003
- 34 x 40 cm: 38 340 003
- 40 x 40 cm: 38 400 003
- 45 x 40 cm: 38 450 003
- 50 x 40 cm: 38 500 003
- 55 x 40 cm: 38 550 003
- 65 x 40 cm: 38 650 003



10 400 003 ^c
 Pop-up waste and overflow closable by hand
 Sistema piletta con troppo pieno può essere chiuso a mano
 Juego de válvula semiautomática y rebosadero de cierre manual



10 410 003 ^c
 Pop-up waste and overflow with electronic control
 Sistema piletta con troppo pieno con controllo elettronico
 Juego de válvula semiautomática y rebosadero electrónico



10 405 003 ^c
 Pop-up waste and overflow with knob
 Sistema piletta con troppo pieno con pomello
 Juego de válvula semiautomática y rebosadero con tirador



10 415 003 ^{c, d}
 Pop-up waste and overflow closable by hand
 Sistema piletta con troppo pieno può essere chiuso a mano
 Juego de válvula semiautomática y rebosadero de cierre manual



84 700 000
 Cutting board
 Tagliere
 Tabla de cortar

^b Item not available in finishes 08, 09 and 99. / Articolo non disponibile nelle superfici 08, 09 e 99. / Artículo no disponible en los acabados 08, 09 y 99.

^c Pop-up waste and overflow sets are only compatible with single sinks in Polished Stainless Steel. / Le pilette e troppopieno sono compatibili solo con i singoli lavelli in acciaio inox lucido. / Los juegos de desagüe y rebosadero solo son compatibles con fregaderos individuales en acero inox pulido.
^d This item is only compatible with item 38 180 003. / Questo articolo è compatibile soltanto con il 38 180 003. / Este artículo solo es compatible con el 38 180 003.



ELIO





^{EN} Its discreet yet pragmatic design makes ELIO particularly adaptable. A universal shape that goes well in simple, functional kitchens.

^{IT} Il design discreto ma pragmatico rende ELIO particolarmente versatile. Una forma universale che si inserisce in cucine semplici e funzionali.

^{ES} Su diseño sobrio y al mismo tiempo pragmático logra que ELIO se adapte a todo. Una forma universal que encaja en cocinas funcionales y sobrias.



The Casual



ELIO BRUSHED CHROME

casual
flexible
pragmatic

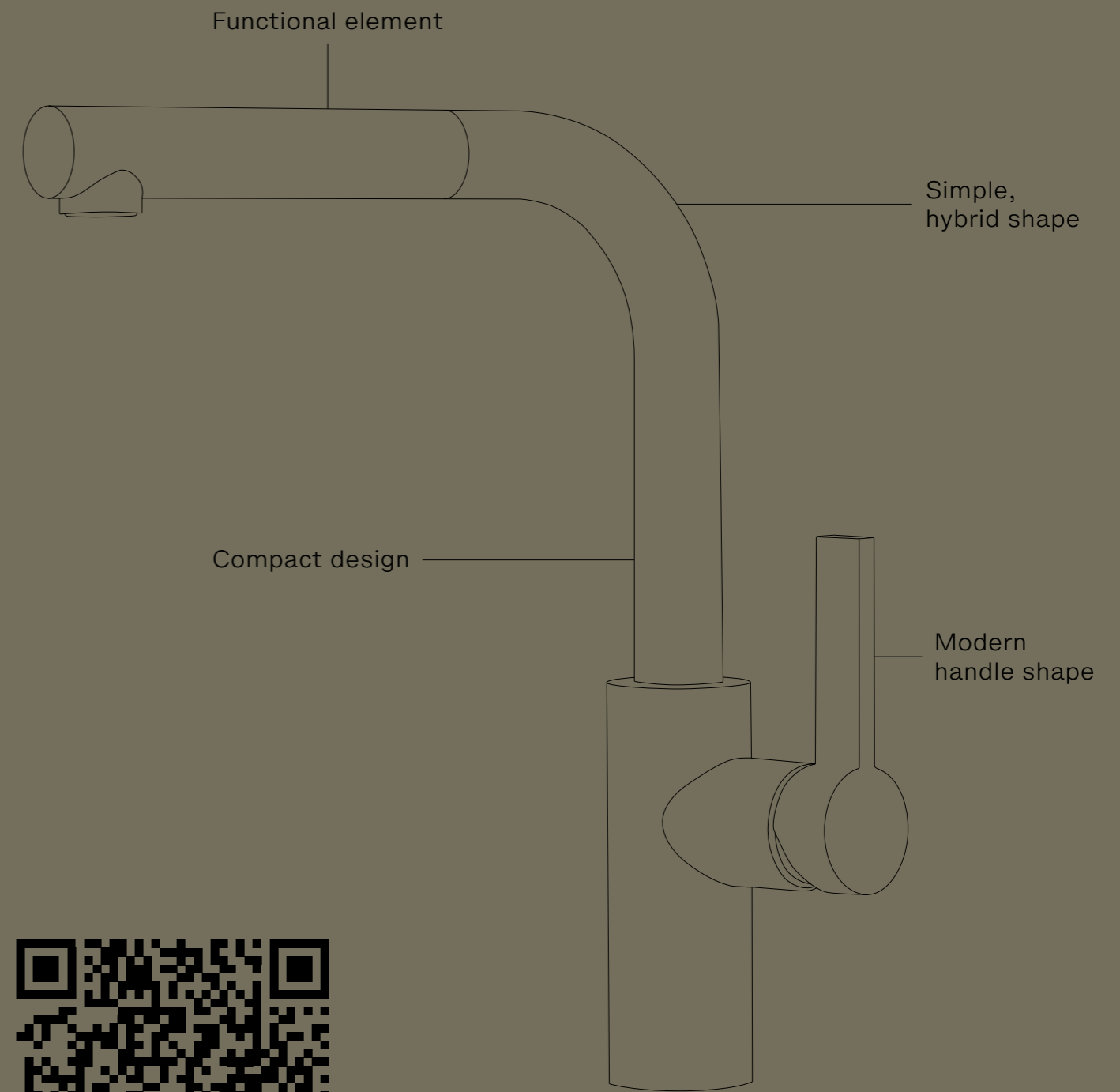

Find out more about ELIO at dornbracht.com/elio



Flowing Brightness

^{EN} Stylish, harmonious, dynamic: round shapes define the look of ELIO. They translate into an ergonomic design that makes daily movement sequences in the kitchen easy.

HCWD not available in Germany

^{IT} Elegante, armonioso, dinamico: le forme rotonde determinano l'aspetto di ELIO. Si traducono in un design ergonomico che facilita gli spostamenti quotidiani in cucina.

HCWD non disponibile in Germania

^{ES} Con estilo, armonía y dinamismo: las formas redondas determinan el aspecto de ELIO. Se plasman en un diseño ergonómico que facilita los movimientos cotidianos en la cocina.

HCWD no disponible en Alemania



^{EN} Whether washing dishes or vegetables, the extending spout makes ELIO in Chrome a flexible addition to the kitchen.

^{IT} Per lavare piatti o verdure: ELIO in cromo è flessibile da usare grazie la sua bocca estraibile.

^{ES} Al lavar los platos o la verdura: ELIO en Cromo ofrece un manejo flexible gracias a su caño de salida extraíble.



Work With
the Flow

EN Thanks to the PULL-OUT function, the fitting is adaptable and expands easily across the working area. Another practical feature is the HOT & COLD WATER DISPENSER.

HCWD not available in Germany

IT Grazie alla funzione PULL-OUT, il rubinetto è adattabile e facilmente espandibile all'area di lavoro. In particolare sottolineiamo la praticità della versione HOT & COLD WATER DISPENSER.

HCWD non disponibile in Germania

ES Con la función PULL-OUT la grifería tiene una gran capacidad de adaptación y puede extenderse sobre el área de trabajo. HOT & COLD WATER DISPENSER también resulta especialmente práctico.

HCWD no disponible en Alemania



linen & cotton
glass tiles
wooden slats
concrete & terrazzo



Materials



ELIO Selected Products

^{EN} ELIO masters every challenge – for an uncomplicated life in the kitchen. The series offers you a wide range of finishes and possible applications – with optional extendable elements.

^{IT} ELIO offre un'ampia gamma di finiture e possibilità di applicazione, opzionalmente con un elemento estraibile.

^{ES} ELIO supera todos los retos: para trabajar sin complicaciones en la cocina. La serie le ofrece una gran variedad de acabados y posibilidades de uso: opcionalmente con un elemento extraíble.

Product Information
 Informazioni sui prodotti
 Información de producto

^{EN} Excerpt from the product range.
 More detailed information can be obtained from your dealer. Due to the printing technique used here, the colours shown may vary from the true colour of the actual finish.

^{IT} Estratto dalla gamma completa prodotti.
 Il Vostro rivenditore specializzato sarà lieto di fornirvi maggiori informazioni. Per motivi tecnici di stampa non possiamo garantire la fedeltà dei colori qui riprodotti.

^{ES} Extracto del programa de productos.
 Si desea más información consulte con su comercio habitual. Los acabados reproducidos en el presente catálogo no son vinculantes por razones de impresión.

Finishes for fittings
 Finiture rubinetteria
 Acabados grifería



00
 Chrome
 Cromato
 Cromo



93
 Brushed Chrome
 Cromo spazzolato
 Cromo cepillado



08
 Platinum
 Platinato
 Platino



06
 Brushed Platinum
 Platinato spazzolato
 Platino cepillado



47
 Champagne (22kt Gold)
 Champagne (Oro 22k)
 Champagne (Oro 22k)

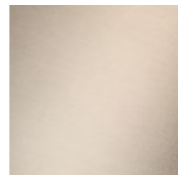

46
 Brushed Champagne
 (22kt Gold)
 Champagne spazzolato
 (Oro 22k)
 Champagne cepillado
 (Oro 22k)

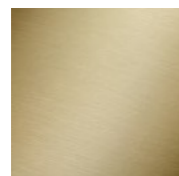

28
 Brushed Durabronze
 (23kt Gold)
 Ottone spazzolato
 (Oro 23k)
 Latón cepillado (Oro 23k)



19
 Dark Chrome
 Dark Chrome
 Dark Chrome

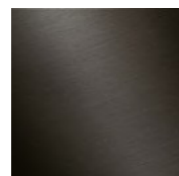

99
 Brushed Dark Platinum
 Dark Platinum spazzolato
 Dark Platinum cepillado

Fittings
 Rubinetti
 Griferías



33 870 790
 Single-lever mixer
 with spray function
 Miscelatore monocomando
 ad estrazione Pull-out
 con funzione doccia
 Monomando Pull-out con
 función de chorro
 [max. 8 l/min.]



33 826 790 + 27 789 970^b
 Single-lever mixer with Profi spray set
 Miscelatore monocomando con gruppo
 doccia professionale
 Monomando con rociador de cocina
 profesional
 [max. 8 l/min.]



33 840 790
 Single-lever mixer Pull-out
 Miscelatore monocomando
 ad estrazione Pull-out
 Monomando Pull-out
 [max. 8,8 l/min.]



32 800 790
 Two-hole mixer with
 individual rosettes
 Miscelatore monocomando
 a due fori con rosette separate
 Batería monomando de dos
 orificios con rosetas individuales
 [max. 8 l/min.]



17 861 790^a
 HOT & COLD WATER DISPENSER
 HOT & COLD WATER DISPENSER
 HOT & COLD WATER DISPENSER
 [max. 2 l/min.]



32 800 790 + 27 721 970
 Two-hole mixer with individual
 flanges with side spray set
 Miscelatore monocomando a
 due fori con rosette separate con
 gruppo doccia lavello
 Batería monomando de dos
 orificios con rosetas individuales
 con rociador de cocina
 [max. 8 l/min.]



33 800 790
 Single-lever mixer
 Miscelatore monocomando
 Monomando
 [max. 8 l/min.]



32 800 790 + 27 789 970^b
 Two-hole mixer with individual
 flanges with Profi spray set
 Miscelatore monocomando a
 due fori con rosette separate con
 gruppo doccia professionale
 Batería monomando de dos
 orificios con rosetas individuales
 con rociador de cocina profesional
 [max. 8 l/min.]



33 826 790 + 27 721 970
 Single-lever mixer with
 side spray set
 Miscelatore monocomando
 con gruppo doccia lavello
 Monomando con rociador
 de cocina
 [max. 8 l/min.]



30 805 875^c
 POT FILLER Cold-water valve
 POT FILLER rubinetto acqua fredda
 con bocca girevole
 POT FILLER Válvula de agua fría
 [max. 5,7 l/min.]

^a You need the corresponding system components for this product. This product is not available in Germany. / Per questo prodotto, sono necessari componenti di sistema appropriati. Questo prodotto non è disponibile in Germania. / Para este producto necesita los componentes de sistema adecuados. Este producto no puede solicitarse en Alemania.

^b Item not available in finishes 47, 46 and 28. / Articolo non disponibile nelle superfici 47, 46 e 28. / Artículo no disponible en los acabados 47, 46 y 28.

^c A rough parts kit is required for this article. Artikel is niet beschikbaar in het oppervlak 33. / Per questo articolo è necessario un kit di parti ad incasso. Artículo no disponible nella superficie 33. / Se requiere un kit de partes empotradas para este artículo. Artículo no disponible en el acabado 33.

Accessories

Accessori

Complementos



82 424 970
Dispenser without rosette
Dispenser senza rosetta
Dispensador sin roseta



83 060 979^d
Towel bar
Asta portasciugamani
Barra colgador



10 713 970
AIR SWITCH Control button
AIR SWITCH pulsante di comando
AIR SWITCH botón de manejo



83 080 979^d
Towel bar
Asta portasciugamani
Barra colgador



10 712 970
Strainer waste with control handle
Comando piletta ad eccentrico con manopola
Accionamiento excéntrico manual con maneta de control giratoria



12 715 970
Cover for tap hole
Copertura per foro di montaggio
Tapón de orificio



83 251 220
Hooks
Gancio
Gancho

Sinks and accessories

Universal

Lavelli e accessori da cucina

Serie neutra

Fregaderos y complementos

Genérico

DESIGN COLLECTIONS ELIO



Single sink in polished stainless steel, available in the following dimensions:

Lavello singolo in acciaio inox lucido, Disponibile nelle seguenti misure:

Fregadero individual de acero inox pulido, disponible en las siguientes medidas:

18 x 40 cm: 38 180 003
34 x 40 cm: 38 340 003
40 x 40 cm: 38 400 003
45 x 40 cm: 38 450 003
50 x 40 cm: 38 500 003
55 x 40 cm: 38 550 003
65 x 40 cm: 38 650 003

85
Polished Stainless Steel
Acciaio inox lucido
Acero inox pulido



10 400 003^e
Pop-up waste and overflow closable by hand
Sistema piletta con troppo pieno può essere chiuso a mano
Juego de válvula semiautomática y rebosadero de cierre manual



10 410 003^e
Pop-up waste and overflow with electronic control
Sistema piletta con troppo pieno con controllo elettronico
Juego de válvula semiautomática y rebosadero electrónico



10 405 003^e
Pop-up waste and overflow with knob
Sistema piletta con troppo pieno con pomello
Juego de válvula semiautomática y rebosadero con tirador



10 415 003^{e, f}
Pop-up waste and overflow closable by hand
Sistema piletta con troppo pieno può essere chiuso a mano
Juego de válvula semiautomática y rebosadero de cierre manual



84 700 000
Cutting board
Tagliere
Tabla de cortar

^d Item not available in finishes 08, 09 and 99. / Articolo non disponibile nelle superfici 08, 09 99. / Artículo no disponible en los acabados 08, 09 y 99.

^e Pop-up waste and overflow sets are only compatible with single sinks in Polished Stainless Steel. / Le pilette e troppopieno sono compatibili solo con i singoli lavelli in acciaio inox lucido. / Los juegos de desagüe y rebosadero solo son compatibles con fregaderos individuales en acero inox pulido.

^f This item is only compatible with item 38 180 003. / Questo articolo è compatibile soltanto con il 38 180 003. / Este artículo solo es compatible con el 38 180 003.



ENO



EN ENO is functional and understated in design, yet smart in the details. With a cold-start function to support an economical hot water consumption, the compact shape meets a wide range of requirements including in small spaces.

IT Il design di ENO è funzionale e dai dettagli curati. Grazie alla funzione di apertura a freddo, permette un sostanziale risparmio nel consumo di acqua calda e, con la sua forma compatta, soddisfa una vasta gamma di esigenze anche in spazi ridotti.

ES El diseño de ENO es sobrio y discreto, pero con detalles inteligentes. Con su función de inicio frío, fomenta un consumo reducido del agua caliente. Con su forma compacta, es capaz de colmar grandes exigencias en espacios reducidos.



The Conscious



ENO CHROME

smart
intuitive
simple

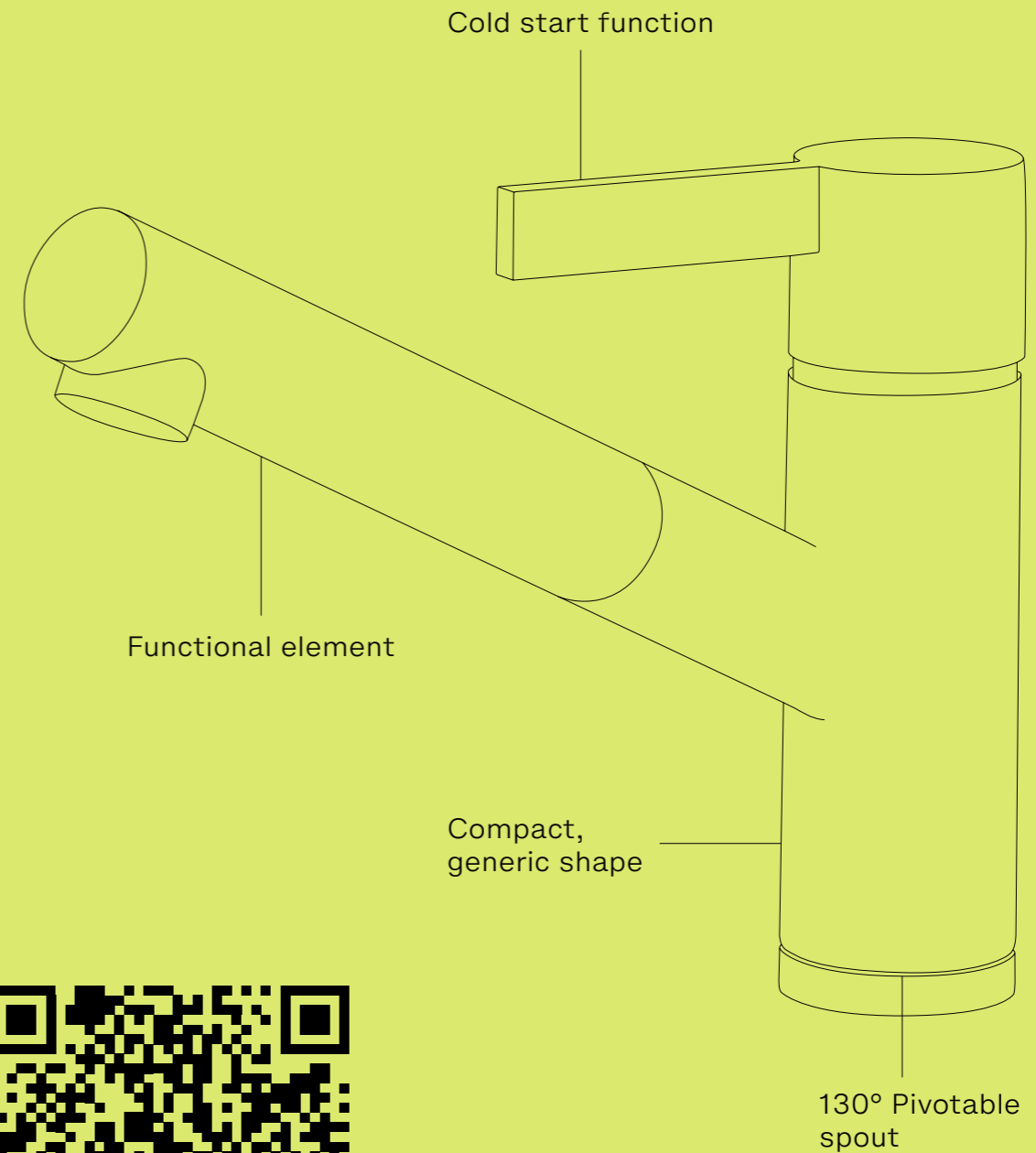

Find out more about ENO at dornbracht.com/en0



Conscious Simplicity

EN Aesthetic in design and smart in function, ENO fits perfectly in smaller kitchens. Thanks to the compact ergonomic shape, it fits beautifully under wall cabinets.

IT Funzionale nel design, ENO si inserisce perfettamente in cucine di piccole dimensioni: grazie alla sua forma compatta ed ergonomica, è ideale per essere posizionato sotto i pensili.

ES De diseño sobrio y funcionalidad inteligente, ENO se integra perfectamente en cocinas de pequeñas dimensiones: gracias a su forma compacta y ergonómica, todo encuentra su espacio bajo los armarios suspendidos.



^{EN} Cold water flows when the lever is in the neutral position – which means that ENO's lever concept intuitively helps to reduce hot water consumption.

^{IT} Nella posizione della leva neutra, scorre solo acqua fredda, in questo modo l'apertura della leva aiuta intuitivamente a ridurre il consumo di acqua calda.

^{ES} En posición de palanca neutral, se obtiene solo agua fría, por lo que el concepto de palanca de ENO ayuda intuitivamente a reducir el consumo de agua caliente.

Functional Flexibility



EN With its various functional elements, ENO is the perfect fitting for small urban kitchens. In addition to the classic single-lever mixer, ENO is also available as a PULL-OUT fitting with an extendable spray or spout.

IT Con le sue diverse varianti funzionali, ENO è il rubinetto ideale per piccole cucine urbane. Oltre al classico miscelatore monocomando, ENO è disponibile come rubinetto con doccetta a doppio getto PULL-OUT o bocca estraibile.

ES Con sus diferentes variantes funcionales, ENO es la grifería ideal para las pequeñas cocinas urbanas. Además de la clásica de mezclador monomando, ENO también está disponible como grifería PULL-OUT con grifo extraíble o caño de salida extraíble.

dark slate
stainless steel
grey terrazzo
shapes and colours

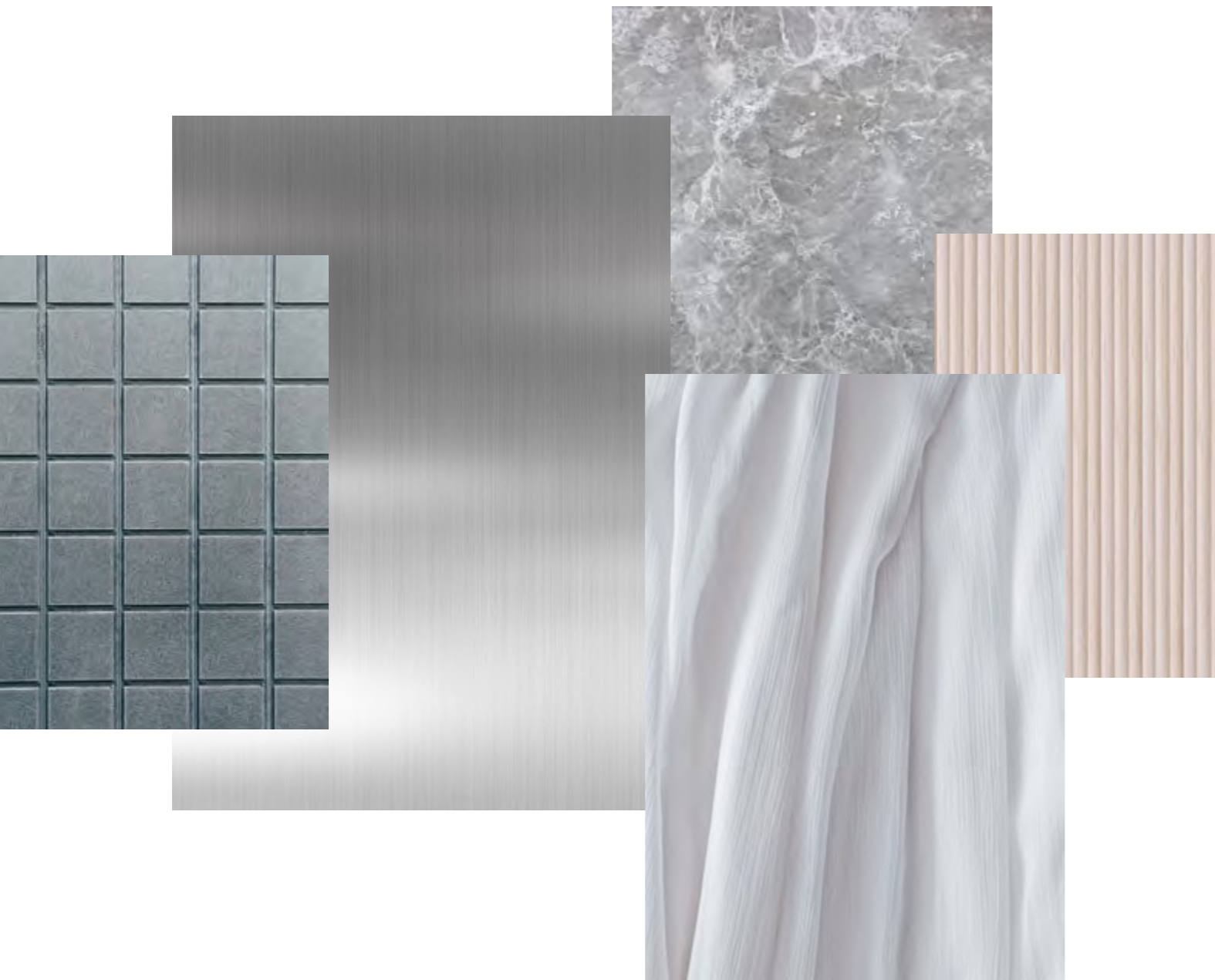

Materials



EN Available in individual different ranging from Chrome and Brushed Dark Platinum to Brushed Durabross (23kt Gold), ENO offers a variety of options for different style worlds – in addition to the accessories for your kitchen.

IT L'ampiezza della gamma finiture, dal Cromato, al Dark Platinum spazzolato all'Ottone spazzolato (Oro 23 ct), ENO offre ispirazione per diversi mondi di stile in abbinamento agli accessori per la vostra cucina.

ES Con acabados individuales desde Cromo, Dark Platinum cepillado hasta Latón cepillado (Oro 23k), ENO ofrece una selección inspiradora para diversos estilos: además de complementos para su cocina.



ENO Selected Products

Product Information
 Informazioni sui prodotti
 Información de producto

^{EN} Excerpt from the product range.
 More detailed information can be obtained from your dealer. Due to the printing technique used here, the colours shown may vary from the true colour of the actual finish.

^{IT} Estratto dalla gamma completa prodotti.
 Il Vostro rivenditore specializzato sarà lieto di fornirvi maggiori informazioni. Per motivi tecnici di stampa non possiamo garantire la fedeltà dei colori qui riprodotti.

^{ES} Extracto del programa de productos.
 Si desea más información consulte con su comercio habitual. Los acabados reproducidos en el presente catálogo no son vinculantes por razones de impresión.

Finishes for fittings
 Finiture rubinetteria
 Acabados grifería



00
 Chrome
 Cromato
 Cromo



93
 Brushed Chrome
 Cromo spazzolato
 Cromo cepillado



08
 Platinum
 Platinato
 Platino

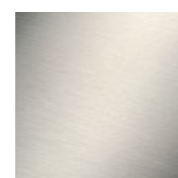

06
 Brushed Platinum
 Platinato spazzolato
 Platino cepillado



47
 Champagne (22kt Gold)
 Champagne (Oro 22k)
 Champagne (Oro 22k)

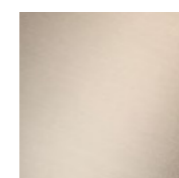

46
 Brushed Champagne
 (22kt Gold)
 Champagne spazzolato
 (Oro 22k)
 Champagne cepillado
 (Oro 22k)

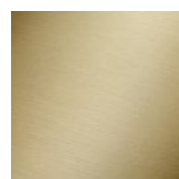

28
 Brushed Durabrass
 (23kt Gold)
 Ottone spazzolato
 (Oro 23k)
 Latón cepillado (Oro 23k)



19
 Dark Chrome
 Dark Chrome
 Dark Chrome

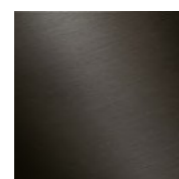

99
 Brushed Dark Platinum
 Dark Platinum spazzolato
 Dark Platinum cepillado

Fittings
 Rubinetti
 Griferías



33 870 760
 Single-lever mixer Pull-out with spray function
 Miscelatore monocomando ad estrazione Pull-out con funzione doccia
 Monomando Pull-out con función de chorro
 [max. 8,3 l/min.]



30 805 875 ^a
 POT FILLER Cold-water valve
 POT FILLER rubinetto acqua fredda con bocca girevole
 POT FILLER Válvula de agua fría
 [max. 5,7 l/min.]



33 875 760
 Single-lever mixer Pull-out with spray function
 Miscelatore monocomando ad estrazione Pull-out con funzione doccia
 Monomando Pull-out con función de chorro
 [max. 9,6 l/min.]



33 840 760
 Single-lever mixer Pull-out
 Miscelatore monocomando ad estrazione Pull-out
 Monomando Pull-out
 [max. 8 l/min.]



33 845 760
 Single-lever mixer Pull-out
 Miscelatore monocomando ad estrazione Pull-out
 Monomando Pull-out
 [max. 10 l/min.]



33 800 760
 Single-lever mixer
 Miscelatore monocomando
 Monomando
 [max. 8 l/min.]

^a A rough parts kit is required for this article. Item not available in finish 33. / Per questo articolo è necessario un kit di parti ad incasso. Articolo non disponibile nella superficie 33. / Se requiere un kit de partes empotradas para este artículo. Artículo no disponible en el acabado 33.

Accessories
 Accessori
 Complementos

Sinks and accessories Universal
 Lavelli e accessori da cucina Serie neutra
 Fregaderos y complementos Genérico



82 424 970
 Dispenser without rosette
 Dispenser senza rosetta
 Dispensador sin roseta



83 060 979 ^b
 Towel bar
 Asta portasciugamani
 Barra colgador



10 713 970
 AIR SWITCH Control button
 AIR SWITCH pulsante di comando
 AIR SWITCH botón de manejo



83 080 979 ^b
 Towel bar
 Asta portasciugamani
 Barra colgador



10 712 970
 Excenterbetätigung mit Drehknopf
 Comando piletta ad eccentrico con manopola
 Accionamiento excéntrico manual con maneta de control giratoria



12 715 970
 Cover for tap hole
 Copertura per foro di montaggio
 Tapón de orificio



83 251 220
 Hooks
 Gancio
 Gancho



34 x 40 cm

85
 Polished Stainless Steel
 Acciaio inox lucido
 Acero inox pulido

Single sink in polished stainless steel, available in the following dimensions:

Lavello singolo in acciaio inox lucido, Disponibile nelle seguenti misure:

Fregadero individual de acero inox pulido, disponible en las siguientes medidas:

- 18 x 40 cm: 38 180 003
- 34 x 40 cm: 38 340 003
- 40 x 40 cm: 38 400 003
- 45 x 40 cm: 38 450 003
- 50 x 40 cm: 38 500 003
- 55 x 40 cm: 38 550 003
- 65 x 40 cm: 38 650 003



10 400 003 ^c
 Pop-up waste and overflow closable by hand
 Sistema piletta con troppo pieno può essere chiuso a mano
 Juego de válvula semiautomática y rebosadero de cierre manual



10 410 003 ^c
 Pop-up waste and overflow with electronic control
 Sistema piletta con troppo pieno con controllo elettronico
 Juego de válvula semiautomática y rebosadero electrónico



10 405 003 ^c
 Pop-up waste and overflow with knob
 Sistema piletta con troppo pieno può essere chiuso a mano
 Juego de válvula semiautomática y rebosadero con tirador



10 415 003 ^{c, d}
 Pop-up waste and overflow closable by hand
 Sistema piletta con troppo pieno può essere chiuso a mano
 Juego de válvula semiautomática y rebosadero de cierre manual



84 700 000
 Cutting board
 Tagliere
 Tabla de cortar

^b Item not available in finishes 08, 09 and 99. / Articolo non disponibile nelle superfici 08, 09 e 99. / Artículo no disponible en los acabados 08, 09 y 99.

^c Pop-up waste and overflow sets are only compatible with single sinks in Polished Stainless Steel. / Le pilette e troppopieno sono compatibili solo con i singoli lavelli in acciaio inox lucido. / Los juegos de desagüe y rebosadero solo son compatibles con fregaderos individuales en acero inox pulido.
^d This item is only compatible with item 38 180 003. / Questo articolo è compatibile soltanto con il 38 180 003. / Este artículo solo es compatible con el 38 180 003.





x-tra Service

Unique
Solutions

Everything Starts With Your Idea

^{EN} Everything is possible with Dornbracht's x-tra Service: together we'll transform your vision into a reality – tailor-made and with great attention to detail. Imagination knows almost no bounds: the options range from individual finishes and textures to refinements with the series of your choice. Talk to us! Our x-tra Service Team is looking forward to hearing from you and your ideas.

^{IT} Tutto è possibile con Dornbracht x-tra Service: insieme realizziamo la vostra visione di uno spazio cucina su misura e con la massima attenzione ai dettagli. Non ci sono quasi limiti all'immaginazione: le possibilità spaziano da modifiche funzionali e strutturali a singole finiture personalizzate. Contattateci! Il nostro team di assistenza sarà lieto di ascoltare voi e le vostre idee.

^{ES} Con x-tra Service de Dornbracht, todo es posible: juntos plasmamos la cocina de sus sueños – a medida, y con un gran mimo por los detalles. Y apenas ponemos límite a la fantasía: las posibilidades abarcan desde acabados y estructuras individuales hasta refinamientos con el material que desee. ¡Póngase en contacto con nosotros! Nuestro equipo x-tra Service estará encantado de atenderle y conocer sus ideas.



Find out more about our customization services on dornbracht.com/xtra-service-contact

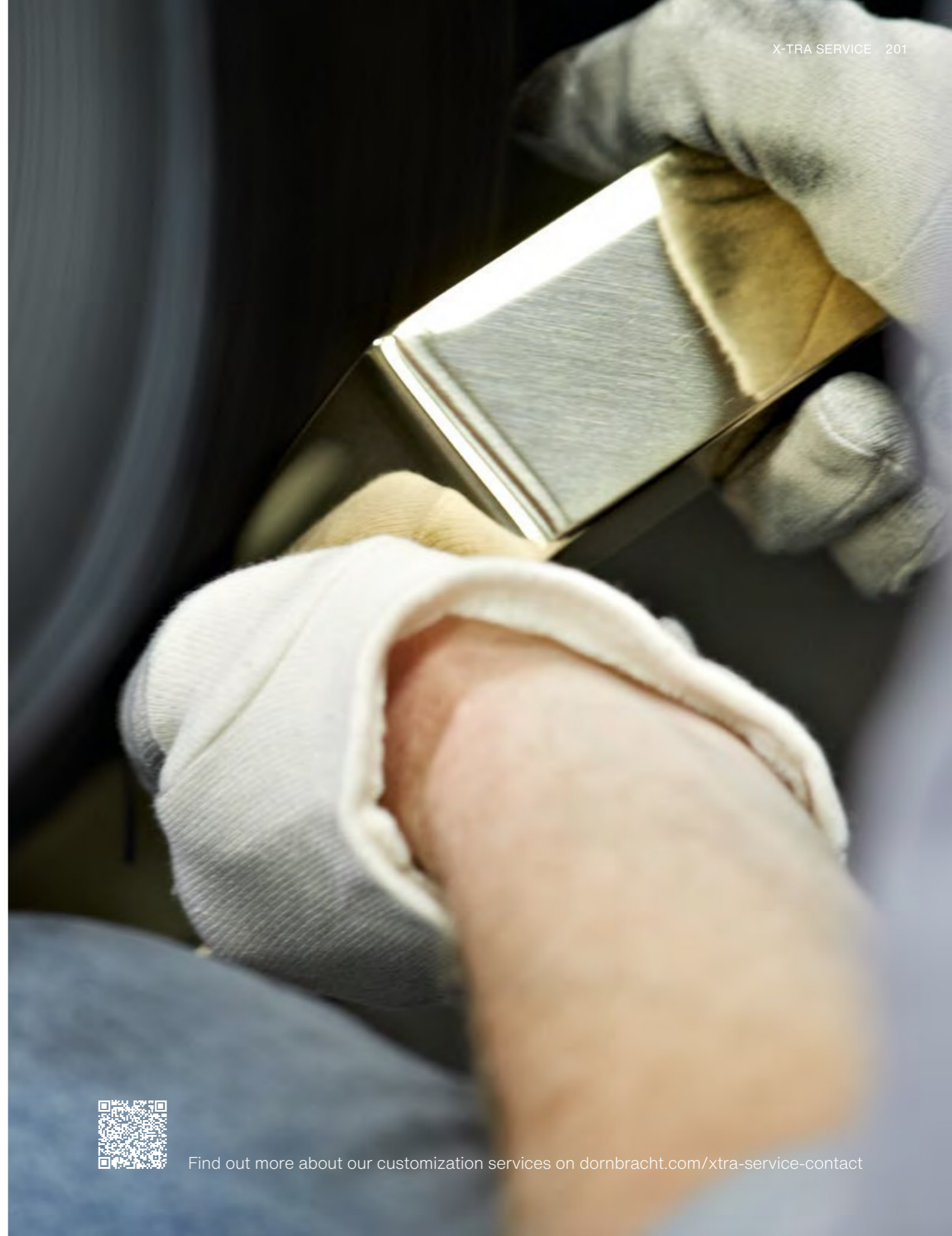



Sustainability

A Question
of Attitude



Sustainability: Our Contribution

^{EN} The aim and conviction to act sustainably are with us right from the start. This is an attitude that influences every decision about quality, materials, manufacturing processes, and suppliers. Having signed up to the UN Sustainable Development Goals here at Dornbracht, we are not just declaring our support for long-lasting products and designs that endure. We also advocate sustainable production and the responsible use of our products – such as through our comprehensive repair and refurbishment service. Our manufacturing and marketing have been climate-neutral since 2021. To further increase our contribution to climate protection, we continuously improve our energy and resource efficiency with innovative products and solutions. We have, for example, been able to significantly reduce the water consumption of our fittings and rain showers over the last few years.

^{IT} L'aspirazione e la convinzione di agire in modo sostenibile ci hanno accompagnato fin dall'inizio. Un atteggiamento che influenza ogni decisione riferita a qualità, materiali, processi produttivi e fornitori. In quanto firmatari degli obiettivi di sviluppo sostenibile delle Nazioni Unite, noi di Dornbracht non contribuiamo solo nel realizzare prodotti di design durevoli nel tempo ma ci impegnamo anche per la produzione sostenibile e l'uso responsabile dei nostri prodotti. Ad esempio, attraverso il nostro ampio servizio di riparazione e ricondizionamento. Dal 2021 produciamo e vendiamo in modo neutrale dal punto

di vista climatico. Per aumentare ulteriormente il nostro contributo alla protezione dell'ambiente, miglioriamo continuamente la nostra efficienza energetica e delle risorse attraverso prodotti e soluzioni innovative. Negli ultimi anni siamo stati in grado di ridurre significativamente il consumo di acqua dei nostri rubinetti e soffioni a pioggia.

^{ES} La exigencia y la convicción de actuar de forma sostenible nos acompañan desde nuestros orígenes. Una postura que influye en cada decisión sobre calidad, materiales, procesos de fabricación y proveedores. Como firmantes de los objetivos de sostenibilidad de la ONU, en Dornbracht no solo profesamos productos de larga vida y diseños duraderos. También apostamos por una producción sostenible y un uso responsable de nuestros productos: por ejemplo, con nuestro amplio servicio de reparación y restauración. Desde 2021, producimos y comercializamos con neutralidad climática. Para seguir aumentando nuestro compromiso con la protección climática, mejoramos continuamente nuestra eficiencia energética y de recursos con nuestros innovadores productos y soluciones. Así, por ejemplo, hemos logrado reducir de forma significativa el consumo de agua de nuestras griferías y duchas de lluvia.



Explore our sustainability projects:
dornbracht.com/sustainability





^{EN} With Dornbracht ReCrafted, we recondition design icons in the original Dornbracht manufacturing quality. Discover our selection now at dornbracht-recrafted.shop

Available in most EU market

^{IT} Con Dornbracht ReCrafted, rigeneriamo icone di design con la qualità di produzione originale Dornbracht. Scoprite la nostra selezione all'indirizzo dornbracht-recrafted.shop

Disponibile nella maggior parte dei mercati dell'UE

^{ES} Con Dornbracht ReCrafted, reacondicionamos iconos de diseño con la calidad de fabricación original de Dornbracht. Descubra ahora nuestra selección en dornbracht-recrafted.shop

Disponibile en la mayoría de los mercados de la UE



Find out more on dornbracht-recrafted.shop

Finishes Overview

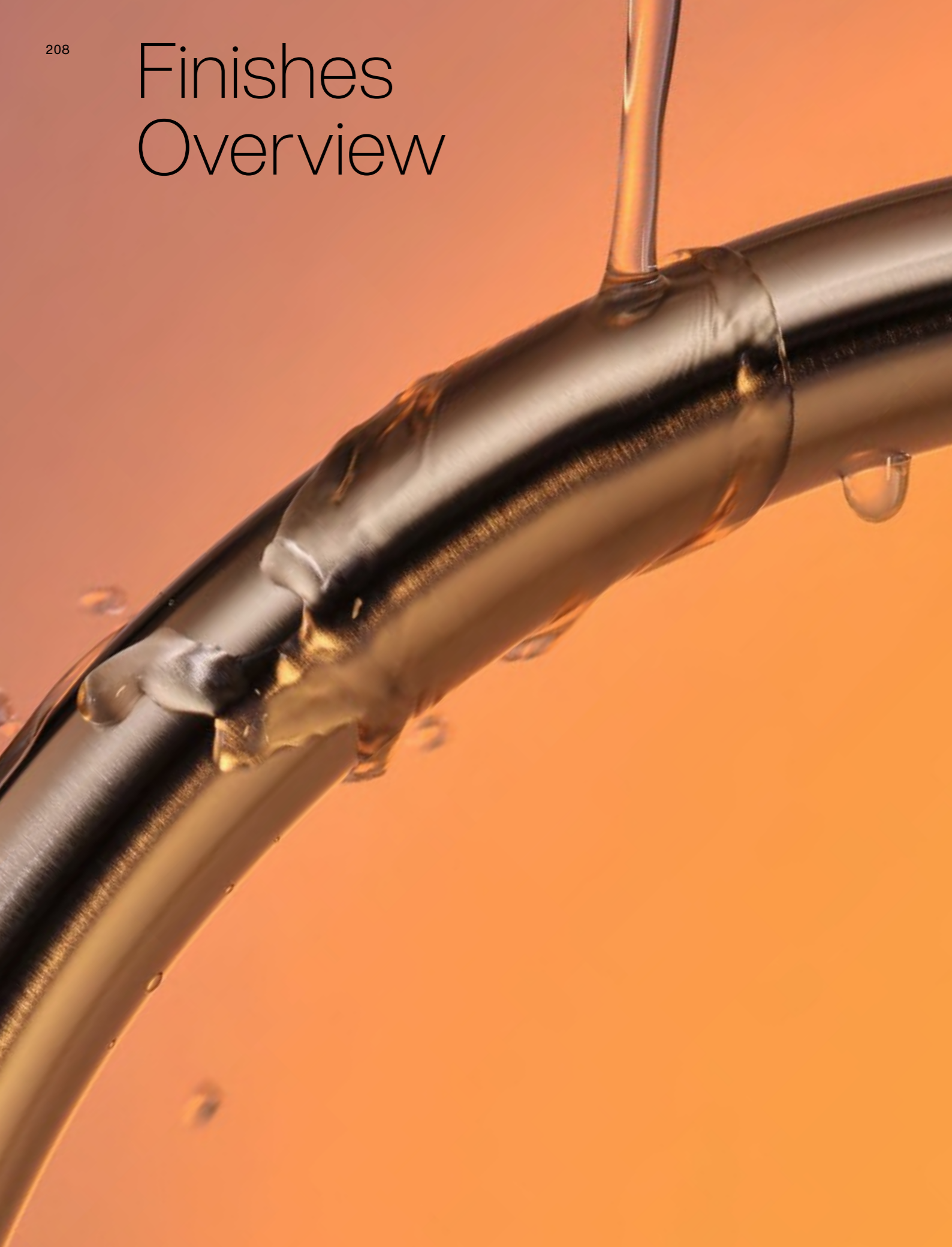

^{EN} Our carefully curated finishes provide you with varied and high-quality solutions for many styles and architectures. They are deliberately chosen and coordinated to ensure maximum design freedom, as well as an assured sense of style and durability. Do you have your own ideas? Dornbracht x-tra Service will also implement customised solutions for you.

^{IT} Le nostre finiture di alta qualità offrono soluzioni diverse per una varietà di stili e architetture. Accuratamente selezionate e coordinate, garantiscono la massima libertà di progettazione mantenendo il loro stile duraturo. Avete nuove idee da implementare? Il reparto Dornbracht x-tra service realizza soluzioni individuali e personalizzate.

^{ES} Nuestros acabados minuciosamente combinados le ofrecen numerosas soluciones de calidad para una gran cantidad de estilos y arquitecturas. Seleccionadas y armonizadas conscientemente, le garantizan la máxima libertad de diseño ofreciendo al mismo tiempo estilo seguro y durabilidad. ¿Tiene sus propias ideas? Nuestro equipo x-tra Service de Dornbracht también plasma soluciones individuales para usted.

DISCOVER MORE ON PAGE 200 →

00
Chrome
Cromato
Cromo

93
Brushed Chrome
Cromo spazzolato
Cromo cepillado

08
Platinum
Platinato
Platino

06
Brushed Platinum
Platinato spazzolato
Platino cepillado

47
Champagne (22kt)
Champagne (Oro 22k)
Champagne (Oro 22k)

46
Brushed Champagne (22kt Gold)
Champagne spazzolato (Oro 22k)
Champagne cepillado (Oro 22k)

09
Durabrand (23kt Gold)
Ottone (Oro 23k)
Latón (Oro 23k)

28
Brushed Durabrand (23kt Gold)
Ottone spazzolato (Oro 23k)
Latón cepillado (Oro 23k)

19
Dark Chrome
Dark Chrome
Dark Chrome

99
Brushed Dark Platinum
Dark Platinum spazzolato
Dark Platinum cepillado

33
Matte Black
Nero opaco
Negro mate

Imprint

Product Design
Sieger Design

Architecture
Mike Meiré, Meiré und Meiré

Photography
Ajay Barai / Unsplash, Johannes Bauer,
Guillaume Chabrol / Unsplash, Tillmann Franzen,
Fernando Gomez / Trunk Archive, Jonas von der Hude,
Thomas Popinger, Alexander Sander

Concept, Creation and Editing
Meiré und Meiré, Cologne

Printing
Daneels Media Group, Beerse, Belgium

^{EN} We reserve the right to implement model, program or technical modifications without prior notice. Be inspired and find out more at dornbracht.com

^{IT} Con riserva di errore e di modifiche tecniche, di modifiche ai modelli e alla gamma prodotti. Lasciatevi ispirare su dornbracht.com

^{ES} Nos reservamos el derecho a modificar modelos o colecciones, así como a realizar modificaciones de carácter técnico, y a haber incurrido en errores. Déjese inspirar y descubra mucho más en dornbracht.com

Our Services

5

^{EN} Five-year warranty

^{IT} Cinque anni di garanzia

^{ES} Cinco años de garantía

10

^{EN} Ten-year spare parts service

^{IT} Dieci anni di servizio ricambi

^{ES} Diez años de servicio de piezas de repuesto

^{EN} Dornbracht inspires and creates living spaces that are timeless. Whatever your concern, you can rely on our Dornbracht Service Team to be at your disposal quickly, reliably, and fuss-free.

^{IT} Dornbracht ispira e crea spazi abitativi senza tempo. Il nostro team di assistenza Dornbracht è a vostra disposizione in modo rapido, semplice e affidabile per tutte le vostre esigenze.

^{ES} Dornbracht inspira y crea espacios de vida de duración atemporal. Nuestro equipo de servicios de Dornbracht atenderá todas sus consultas de forma rápida, fiable y sin complicaciones.



Dornbracht AG & Co. KG
Köbbingser Mühle 6, D-58640 Iserlohn
dornbracht.com



Find out more about our services
dornbracht.com/kitchen

01 00 23 981 17



4099477193519



kitchen.dornbracht.com